

DAVID FITCH SERVICES

STAGE LIGHTING AND TECHNICAL THEATRE SUPPLIES

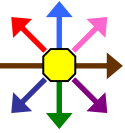

UNIT 12A ROCHESTER AIRPORT INDUSTRIAL ESTATE
LAKER ROAD
ROCHESTER
KENT
ME1 3QX

TELEPHONE 01322 350 351
MOBILE 07860 233 771

email contactus@davidfitchservices.com
web site www.davidfitchservices.com

43 YEARS !



HIRE PRICES



43 YEARS !!

ALL HIRE PRICES QUOTED ARE PER THEATRICAL WEEK, EX WORKS CARRIAGE IS EXTRA.

ALSO PLEASE SEE TERMS AND CONDITIONS. PRICES CORRECT AT TIME OF GOING TO PRESS.

ALL LANTERNS ARE SUPPLIED WITHOUT FILTER. **YOU MUST SEND A WRITTEN ORDER !**

SECTIONS / ITEMS MARKED* DO NOT HAVE DAY RATES, NOR DO LAST MINUTE HIRES (LESS THAN 7 DAYS NOTICE)
ITEMS MARKED *F* ARE FLIGHTCASED AND ARE SENT OUT SO TO PROTECT THE CONTENTS AND THEY REMAIN ON SITE.

PROFILES

	WATTS	GOBO	BEAM ANGLE	PRICE EACH PER WEEK
SOURCE 4 JNR ZOOM	575	M	25°/ 50°	£ 18.00
SOURCE 4 19°, 26° OR 50°	575	B	19°, 26° OR 50°	£ 18.00
SOURCE 4 10°	575	B	10°	£ 30.00
SOURCE 4 5°	575	B	5°	£ 50.00
VIRTUOSO 1000* LED RGBAL	240	B	10°, 19°, 26° OR 50°	£ 50.00
VIRTUOSO 600 * LED RGBAL	150	M	25° - 50° ZOOM	£ 40.00



FRESNELS & PEBBLE CONVEX (PC'S)

INCLUDING BARNDOORS

QUARTET PC / F	650	8°/55°	£ 15.00
PATT 743 / NOTA PC	1000	9°/70°	£ 20.00
MP 180 LED* RGBALC*	180	13°/46°	£ 40.00
MP 75 LED* RGBW*	75	10°/50°	£ 25.00

PATT 743



NOTA



QUARTET



MP 180



MP 75



LED*

(NON DIM ITEMS) *F* CABLES INCLUDED

LED PERFORMER 18 HEX* 40° 6 CHAN DMX R, G, B, W, A AND UV	£ 25.00
LED PERFORMER ZOOM 18* 25°-75° 6 CHAN DMX DIMMER R, G, B, W, AND ZOOM	£ 25.00
LED CANS 144 / 047 SILVER* RGBW 30° 4 CHAN DMX	£ 25.00
LED PERFORMER 200 LED* 4 CHAN DMX RGBW 120°	£ 25.00



HEX MEANS
RED GREEN BLUE
WHITE AMBER AND
UV...VERSATILE !

PLEASE LET US KNOW THE PRECISE DATES FOR YOUR HIRE AS ...AROUND THE END OF MARCH ...IS A BIT VAGUE !
WE DO A THEATRICAL WEEK, WHICH IS THE FRIDAY BEFORE TO THE MONDAY AFTER THE RUN OF THE SHOW.
WE DO NOT WORK ON SUNDAYS OR BANK HOLIDAYS. EVERYONE NEEDS A BIT OF TIME OFF ! NO EXTRA COST !



LIGHTING DESKS (CONTROL CABLE EXTRA EXCEPT WITH LED) *F*

ZERO 88 FLX S48 MEMORY DESK 96 ITEMS 4098 CHANNELS (4 UNIVERSE) £300.00
 ZERO 88 FLX S24 MEMORY DESK 48 ITEMS 1024 CHANNELS £150.00

ZERO 88 JESTER 24/48 MEMORY DESK £ 85.00
 ZERO 88 JESTER 12/24 MEMORY DESK £ 60.00
 PULSAR 6 CHANNEL DESK (INCL 10 M CONTROL CABLE) £ 10.00
 LEVEL 6 DMX DESK £ 10.00
 PULSAR 12 CHANNEL DESK £ 15.00
 PULSAR 18 CHANNEL DESK £ 21.00

CONVERTERS & DEMULTIPLEX UNITS

DMX SPLITTER OR DEMUX £ 20.00

DIMMERS

ANALOGUE RACK. PULSAR 6 X 2Kw £ 30.00
 DMX RACK. ZERO 88 BETAPACK £ 30.00
 PULSAR MINIPACK 3 X 1Kw OR ALPHAPACK £ 20.00
 SINGLE CHANNEL 10 AMP DIMMER £ 10.00

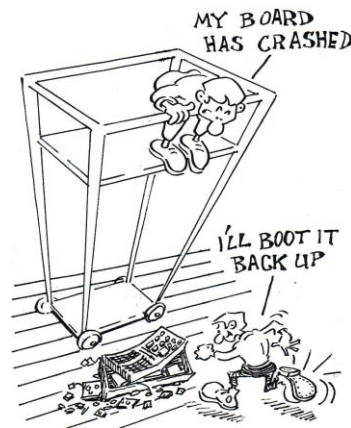

WHEN MARKING UP THE DESK PLEASE USE WHITE PVC TAPE AND A CD MARKER PEN, WHICH WE SELL.. NEVER USE MASKING TAPE, IT IS A PAIN AND BIRO IS A COMPLETE PAIN IN THE.....DARK ! MASKING TAPE NEVER COMES OFFAND YOU CAN'T READ BIRO IN 'ZERO' LIGHT !

APART FROM... ASSEMBLY, BREAK, LUNCH, AND 5 LESSONS, THE HALL IS ALL YOURS....UNTIL YOGA CLASS !

FLOODS

DWE "BLINDER" 4 X 650 40° X 30° £ 25.00
 CODA FLOOD 500 (ASYMMETRICAL) N/A £ 10.00
 IADII 800 (SYMMETRICAL) N/A £ 10.00
 STARLETTE 1250 (ASYMMETRICAL) N/A £ 18.00
 PIXELSTORM 12 LED HEX CYC 12 X 12 W 40° (8) £ 40.00



EXHIBITION LIGHTS / BACKSTAGE WORKING LIGHTS 10W WHITE OR BL UE £ 10.00

PARS

PAR 30 240 VOLT 75 10° £ 10.00
 PAR 16 BIRDIE 12V 50 30° OR 240V 30° £ 10.00
 SPECTRA 40 40W RGBW 4.5° OR 10° OR 25° IP65 RATED £ 25.00
THINK OF IT AS A BIRDIE..... ON STEROIDSCOMING SOON !



FOLLOW SPOTS

(INCLUDING STAND, DIMMER OR BLACKOUT SHUTTER, IRIS AND COLOUR MAGAZINE WHERE AVAILABLE)

FAL SCALA 1200 *F* 1200w HMI 9°/18° £130.00
 CANTATA OPTIQUE *F* 1000w T/H 8°/17° OR 15°/42° £ 65.00
 CANTO 250 *F* 250w MSD 10°/28° £ 65.00
 BEAMLIGHT 500w 24V NO IRIS, NO COLOUR MAG, NARROW SOFT BEAM £ 65.00

IF YOU ARE UNCERTAIN AS TO WHICH FOLLOW SPOT TO CHOOSE, PLEASE CONTACT THE OFFICE. NB THE IRIS FITS IN THE CENTRE OF THE LANTERN AND THE COLOUR MAGAZINE ON THE FRONT. IF MATCHING AN EXISTING SPOT, PLEASE LET US KNOW IN ORDER WE MAY SUPPLY A SIMILAR MODEL.



STAND PACKS—COMPLETE ANALOGUE DIMMER & LIGHTING RIG ON TWO STANDS.

STAND PACKS ARE NOT SUPPLIED WITH FILTERS, HOWEVER WE CAN SUPPLY A FILTER STARTER PACK @ £ 49.00 WHICH WILL LAST FOR SEVERAL SHOWS. PLEASE SEE PAGE 32 FOR DETAILS. WHY USE COLOUR? WHITE LIGHT IS BORING ! ALSO, IT CAN BECOME FATIGUING ON THE EYE. SO STRAW, STEEL BLUE AND PALE GOLD IN INDIVIDUAL LANTERNS GIVES A "THEATRICAL DAYLIGHT" AND BY ADJUSTING THE LEVELS CAN GIVE AN INDOOR FEEL BY MAKING THE PALE GOLD BRIGHTER THAN THE STEEL BLUE. MINOR CHANGES TO THE LEVELS CAN SUGGEST A DIFFERENT LOCATION AND FEEL TO THE SCENE. FOR THE BEST RESULTS, YOU NEED TO SET THE LIGHTS AT THE BEST POSSIBLE HEIGHT, DO YOU HAVE A SUITABLE CLASS 1 INDUSTRIAL STEPLADDER? SEE PAGE 54. IF YOU HAVE A CABLE DRUM WITH YOUR HIRE, UNWIND IT FULLY BEFORE USE ! WITH THE STAND SET AGAINST A WALL AT THE WIDEST, THE THIRD LEG STANDS OFF THE WALL BY 1.4M.....THIS GIVES MAXIMUM STABILITY.

PACK A - WITH SIX 650 WATT FRESNEL OR PC LANTERNS	£ 180.00
PACK B - WITH EIGHT 650 WATT FRESNEL OR PC LANTERNS	£ 220.00
PACK C -WITH TWELVE 650 WATT FRESNEL OR PC LANTERNS	£ 260.00
WIND UP STANDS OPTION, ADD TO THE ABOVE PRICES	£ 40.00

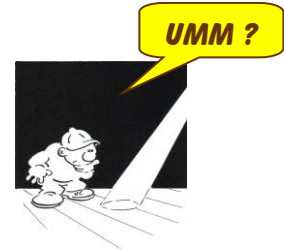
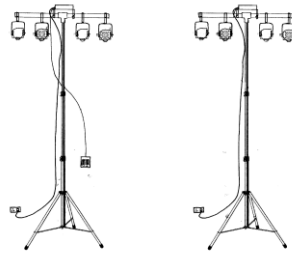

...AND FRANK SENT THIS...

PACK A - WITH SIX SOURCE 4 PROFILE LANTERNS	£ 200.00
PACK B - WITH EIGHT SOURCE 4 PROFILE LANTERNS	£ 250.00
PACK C - WITH TWELVE SOURCE 4 PROFILE LANTERNS, 4 MINI PACKS ON WIND UP STANDS	£ 300.00

LED COLOURPACK TO ADD TO THE ABOVE 6 NO LEDS PLUS UPGRADED DESK & CABLES AS IN PACK D **£ 200.00**

PACK D - WITH TWELVE SOURCE 4 PROFILE LANTERNS, ON WIND UP STANDS AND JESTER MEMORY DESK £ 500.00
WITH LED COLOUR PACK 6 NO LED PARCANS 047 / 144 FOR COLOUR WASH..... FOR THE BEST OF BOTH WORLDS !

LED DANCE PACK - 8 LED 18 X 8W LED QUAD PAR, STANDS, DESK ETC	£ 250.00
LED STAND PACK B - 6 LED 18 X 12W LED HEX PAR, STANDS, DESK ETC	£ 300.00

LEDS REQUIRE A MEMORY DESK TO BE USED TO THEIR BEST, OUR SIMPLE INSTRUCTION SHEET INCLUDED.

WE ALSO DELIVER AND INSTALL THESE SYSTEMS ON HIRE FOR YOUR SHOW. THIS IS A CHARGEABLE SERVICE BUT PLEASE ASK FOR DETAILS. PLEASE ASK AT TIME OF ORDERING .WHEN SENDING OUT A HIRE, WE FLIGHTCASE HIRES WHEREVER POSSIBLE TO PROTECT THE EQUIPMENT. PLEASE TELL US IF YOU ARE COLLECTING IN A CAR AND WE WILL "BAG" THE KIT. JUST "THROWING IT IN THE BACK ...LOOSE".... IS NOT AN OPTION !

A REF 49 STAND CLOSED IS 1.7M LONG X 150MM DIA. WIND UP STANDS ARE 2M LONG X 300MM DIA. T BARS ARE 1.5-2M LONG.

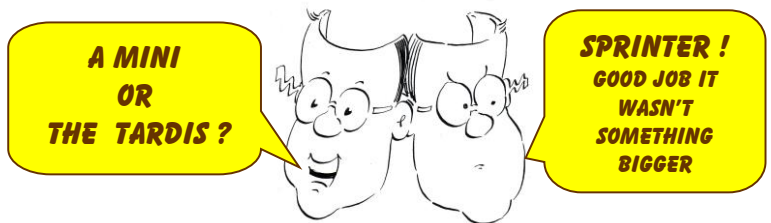

EFFECTS AND EFFECTS PROJECTION

PLEASE ASK FOR VIDEO CLIPS TO BE E-MAILED TO YOU.

PATT 252 COMPLETE INCL EFFECT AND LENS	£ 60.00
252 PROJECTOR	£ 30.00
EFFECTS DISC – FLEECY CLOUDS, STORM CLOUDS, FLAMES, SNOW, WAVES, GALAXY, CLOUDS OVER MOON, SMALL TREES, RUNNING WATER ETC	£ 30.00
LENS 3" , 4" OR 6" FOCAL LENGTH (AS A SEPARATE ITEM)	£ 10.00
DAYLMEYER 4" LENS (HIGH DEFINITION LENS)	£ 12.00
TUBULAR RIPPLE 2000w / 2500w	£ 30.00
TUBULAR RIPPLE 500w	£ 15.00
PATT 123 AND STAND FOR SHADOW PLAY I.E. NO LENS, NEEDS SCREEN	£ 15.00



MOVING LIGHTS (NON-DIM ITEMS) F' DMX CABLES INCLUDED, CONTROL DESK EXTRA.

	DMX CHANNELS		
EQUINOX FUSION 140	(10/15)	WASH	£ 40.00 (5)
EQUINOX FUSION 100	(5/8/15)	SPOT	£ 40.00 (4)
EQUINOX FUSION 200	(2/14/18)	SPOT SOON	£ 75.00
AYRETON DIABLO SP	PROFILE	BEAM SHAPING	£150.00
MARTIN MAC 250	(13)		£ 90.00
MARTIN MAC 500	(16)		£ 100.00
MARTIN MAC 600	(14)		£ 100.00



GOBOS AND IRIS DIAPHRAGMS

IRIS DIAPHRAGM FOR SOURCE FOUR OR JUNIOR ZOOM	£ 10.00
OUR STOCK GOBO AND HOLDER (OUR LIST AVAILABLE ON REQUEST)	£ 8.00
OUR STOCK GOBO OR GOBO HOLDER	£ 4.00
STAINED GLASS WINDOW GOBO (FITS SOURCE FOUR ONLY)	£ 20.00
GLASS GOBO - OUR STOCK- HOLDER EXTRA	£ 15.00



IF YOUR CHOICE OF GOBO OR HOLDER IS NOT A STOCK ITEM FOR US, WE ARE HAPPY TO SELL YOU THE ITEM.
PLEASE ASK FOR A GOBO BROCHURE OR ON OUR WEBSITE WWW.DAVIDFITCHSERVICES.COM.

STROBES AND UV (NON-DIM)

DMX STROBES REQUIRE 2 CHANNELS OF DMX CONTROL - FOR SPEED AND INTENSITY.

HUNGAROFBUSH STROBE 6 Kw DMX, <u>NEEDS</u> 30AMP SUPPLY	£ 50.00
GOLDEN STROBE 1.5Kw DMX STROBE	£ 30.00
LEVEL 6 DMX / SD 6 CONTROLLER FOR STROBES	£ 10.00
FLASH STRINGS 12 X LED STROBES ON 5M STRING RANDOM FLASH((VIDEO CLIP, FRANKENSTEIN)	£ 25.00 (6)
EGG STROBES	£ 5.00
400 WATT ULTRA VIOLET GUN OR 400 WATT ULTRA VIOLET FLOOD*	£ 30.00

ULTRA VIOLET LIGHT SHOWS UP ACNE, GREASE, DANDRUFF, FALSE TEETH, ACRYLIC NAILS, TONIC WATER, WASHING POWDER ON CLOTHES AND WHITE COTTONESPECIALLY UNDERWEAR (WEAR BLACK) IT WON'T SHOW ON SILK OR MAN-MADE FIBRES.

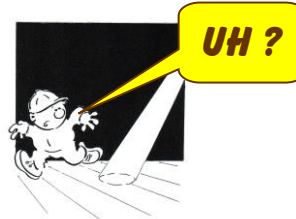

WHEN YOU HIRE STROBES FROM US WE LEND YOU THE WARNING SIGNS OR WE CAN EMAIL THEM FOR YOU TO PRINT.

TALKBACK (PER WAY) F'

FIXED LINE TALK BACK BELT PACK AND HEADSET (INCL 20M + 10M XLR)	£ 18.00
POWER SUPPLY UNIT FOR TALKBACK (PSU)	£ 18.00

ROTATIONAL AND IMAGE EFFECTS F' (NON DIM ITEMS)

DHA ANIMATION DISC & MOTOR / KK WHEEL (FITS SOURCE 4 AND OTHERS)	£ 25.00
GOBO ROTATOR (FITS SIL)	£ 25.00
TWINSPIN (CONTRA-ROTATING GOBOS - FITS SOURCE FOUR)	£ 25.00
IMAGE MULTIPLEXER (FITS SOURCE FOUR, GIVES 6 IMAGES GOOD ON SINGLE IMAGE GOBOS)	£ 12.00
PASSING TRAIN EFFECT (PLEASE ASK FOR DETAILS) F'	£ 25.00

SEARCHLIGHTS*

WORLD WAR 2 SEARCHLIGHTS* 20" REFLECTOR	£ P.O.A.
SMALL WW2 SEARCHLIGHTS* 10" REFLECTOR	£ P.O.A.



DISCO EFFECTS SNOW AND CONFETTI EFFECTS

(NON DIM ITEMS)

TRIPLE WHEEL, DUO GLOBE, COLOUR BURSTS	PLUG AND PLAY	£ 30.00
SNOW MACHINE	GRITTER TYPE PAPER SNOWPLEASE SEE VIDEO CLIP	£ 30.00
SNOW FOR THE ABOVE, 1KG BAG	(SALES APP 10 MINS)	£ 20.00

HAND HELD STREAMER AND CONFETTI CANON

30" (800mm) LONG, SALES

MULTICOLOUR STREAMERS	62040M EASIER TO CLEAR UP	£ 15.00
MULTICOLOURED CONFETTI	62030M	£ 15.00
WHITE CONFETTI	62030W	£ 15.00
RED HEARTS	62030RH	£ 15.00

A BIG EFFECT ! FIREPROOFED AND BIO-DEGRADABLE. WILL GO APP 8-12M. SINGLE USE AND **WE DON'T SWEEP UP!** PLEASE ASK FOR THE VIDEO CLIP.



MUSIC STANDS*

CONDUCTORS STAND		£ 25.00
"RAT" STANDS		£ 15.00
PIANO LIGHTS/ DESK LIGHTS	LED	£ 5.00
13 AMP 4 WAY BLOCK	(1 FOR EVERY 3 STANDS)	£ 1.00

WE NOW SUPPLY 13 AMP 4 WAYS INCLUDED IN THE PRICE OF THE ABOVE ITEMS !

ACCESS EQUIPMENT

10 TREAD STEPLADDER		£ 15.00
13 TREAD STEPLADDER		£ 18.00
11 RUNG REFORM LADDER	(ZARGES TYPE)	£ 20.00
TALLESCOPE 50512	6.4M TOP WORKING HEIGHT	£ 150.00



SO YOU'VE BEEN REHEARSING "MATILDA" FOR 3 MONTHS BUT YOU'VE ONLY JUST GOT ROUND TO ORDERING YOUR HIRE.....SO WHEN DO YOU NEED IT ?
.....**TOMORROW ?????**

PLEASE PUT YOUR WRITTEN ORDER IN AS SOON AS POSSIBLE, AS WE DO NOT LIKE TO SAY....."SORRY, TOO LATE !"

PLEASE TELL YOUR ACCOUNTS DEPARTMENT THAT WE MOVED TO ROCHESTER...IN DECEMBER 2016 ! THE OLD ADDRESSE ARE NO LONGER MONITORED ! AND PLEASE USE THE PAYEE DETAILS ON THE INVOICE.



EXTERNAL LIGHTING* (NON-DIM ITEMS)

PRICE INCLUDES GROUND STAND. LANTERNS HAVE 16 AMP CONNECTORS.

150W METAL HALIDE FLOODS		£ 15.00
ARCHITECTURAL 400W FLOOD	(BLUE LAMP)	£ 20.00
ACL, AIRCRAFT LANDING LIGHTS	(12V 100w VERY NARROW SPOT)	£ 15.00
6M AIRCONES		£ 30.00
FESTOON 25M 25 LAMPS x 4w LED LAMPS	2 (WHITE OR MIXED R/W/B LAMPS NON DIM)	£ 75.00
FESTOON 50M 100 LAMP 2w DIMMABLE WHITE LAMPS	2 SOON	£ 200.00
FAIRY PEA LIGHT STRINGS 100 LAMP 15M	(STATIC WHITE)	£ 20.00
FAIRY LIGHTS STRING 50M LED 500 LAMPS	D 2	£ 40.00
FAIRY LIGHTS STRING 10M LED 100 LAMPS	D 14	£ 10.00
FAIRY LIGHTS STRING 20M LED 200 LAMPS	D 8 STATIC	£ 20.00
LED NET 10M X 8M 880 LAMP	MULTICOURED 4	£ 150.00
LED NET 6M X 4M 200 LAMP	MULTICOURED 1	£ 50.00
LEDJ 281 RGBW 20° 15 X 8W QUAD LED	SOON	£ 40.00



PLEASE ASK FOR OUR LEAFLET ON BUILDING AND ARCHITECTURAL LIGHTING OR OUR BARBECUE AND PARTY LIGHTING SERVICE.



"IT'S SHOWTIME" THE COMPLETE SERVICE

IN ADDITION TO OUR "DRY" HIRE SERVICE WE ARE ALSO HAPPY TO RIG THE LIGHTING, SOUND OR STAGING FOR YOUR PRODUCTION. WE DESIGN, RIG AND TAKE THE SHOW THROUGH REHEARSAL SHOWING YOUR OPERATORS HOW TO RUN THE SHOW. THIS WOULD NORMALLY BE A *TECHNICAL 1* REHEARSAL, WITH JUST A "TOPPING AND TAILING" OF SCENES, THEN A *TECHNICAL 2* TRYING TO RUN THE SHOW IN REAL TIME, FOLLOWED BY THE *DRESS* REHEARSAL WITH YOUR OPERATOR RUNNING THE SHOW, WITH US SITTING BEHIND OFFERING ADVICE ONLY IF NEEDED. WE WOULD THEN RETURN AFTER THE LAST PERFORMANCE TO DE-RIG THE HIRED EQUIPMENT. PLEASE ASK FOR A QUOTATION.

DO YOU KNOW WE DO HAND HELD PROPS AND FAKE FOOD ? WE HAVE OVER **1150** DIFFERENT TYPES ! DID YOU KNOW THAT WE CAN SUPPLY YOU WITH...DIMMERS AND DESKS, LIGHTING STANDS, TRUSSING, LIGHTING EQUIPMENT, LED, MOVING LIGHTS, SPECIAL EFFECTS, SOUND EQUIPMENT WITH RADIO MICS. STARCLOTHS AND STAGING. PLUS OUR SPECIALITY.....MIRROR BALLS ! DID I MENTION IT WAS OURS ON "STRICTLY" ? FIRST 13 SERIES. SMOKE MACHINES, HEAVY FOG MACHINES, FLAMBEAUX (BLOWN SILK, NOT REAL FLAMES!) HAND HELD PROPS AND SET DRESSING. WE RIG AND DE-RIG AS WELL ! PLEASE CALL DAVID TO DISCUSS YOUR REQUIREMENTS.

.....YOU SUPPLY THE PERFORMERS.....WE DO THE TECHNICAL.....



MY FAIR LADY



RAPUNZELL IN LOCKDOWN



BLACK WEDDING

WHEN BOOKING A HIRE, PLEASE CONFIRM IN WRITING OR NO ORDER EXISTS BETWEEN US. PLEASE TELL US THE DATES OF THE SHOW, LAST PERFORMANCE, DELIVERY AND COLLECTION TIME AND OTHER IMPORTANT INFORMATIONIT IS SURPRISING.....HOW MANY PEOPLEER.....FORGET ! SEE PAGE 69 FOR MORE INFORMATION.

PLEASE SEE OUR FACEBOOK PAGE FOR VIDEO CLIPS



MATILDA



FRANKENSTEIN



SCHOOL OF ROCK

SMOKE HAZE AND HEAVY FOG MACHINE:

DMX SMOKE MACHINE HP3000* 60,000 CU FT PER MINUTE
 DMX SMOKE MACHINE Z1200 20,000 CU FT PER MINUTE
 VERTIBLAST, VERTICAL SMOKE MACHINE WITH LEDS
 DNG 100 HEAVY FOG MACHINE INCL LARGE SMOKE MACHINE
 HAZE MACHINE- VAPOUR 1000 5,000 CU FT PER MINUTE !
 SMOKE FLUIDS FOR THE ABOVE PER LITRE
 HAZE FLUIDS FOR THE ABOVE PER LITRE
 DNG FLUID PER LITRE



F
 £ 50.00
 £ 40.00
 £ 30.00
 £ 150.00
 £ 40.00
 £ 5.00
 £ 5.00
 £ 6.00

SMOKE RISES TO ALL LEVELS AND CAN BE QUITE DENSE. HAZE IS A FINER EFFECT THAN SMOKE AND RISES TO ALL LEVELS AND SHOWS THE BEAMS OF LIGHT, WITHOUT FOGGING THE STAGE. HEAVY FOG BEHAVES LIKE DRY ICE BUT IS MORE RELIABLE, SAFER AND.....CHEAPER ! WILL SMOKE EFFECTS SET THE FIRE ALARM OFF ?..... AS THE CHURCHILL DOG SAYS, OH YES ! HAZE AND SMOKE WILL CERTAINLY DO IT, SO ISOLATE THE ZONE BEFORE YOU START AND COVER THE DETECTORS ! THIS CAN BE DONE AS YOU WILL KNOW WHICH ZONE IS ISOLATED BUT THE REST OF THE BUILDING IS PROTECTED. DON'T SWITCH THE ALARM BACK ON UNTIL YOU ARE SURE THE SMOKE HAS GONE ! (OPEN THE WINDOWS AND DOORS)

REMEMBER, IT IS YOUR RESPONSIBILITY TO ENSURE THE FIRE ALARM DOES NOT GO OFF, NOT OURS !



CABLES ETC*

NB CUSTOMERS REQUIRING CABLE, DISTRIBUTION AND ADAPTOR ONLY HIRE ARE CHARGED AT DOUBLE THE RATES SHOWN HERE WITH NO DAY RATES AVAILABLE !

MAINS CABLE

SINGLE PHASE

15 AMP OR 13 AMP OR 16 AMP

3 / 5 M (SHORT)
10 M
20 M

£ 0.50
£ 1.00
£ 2.00

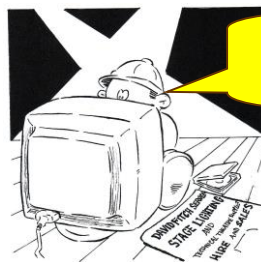

COR ...SO MUCH INFORMATION ON THE WEBSITE !

N.B. A 10 M CABLE IS FREE WITH EACH LANTERN BUT MUST BE REQUESTED WITH THE MAIN ORDER AND PLEASE REMEMBER TO COIL THE CABLES PROPERLY AND TAPE THEM, BEFORE RETURNING YOUR HIRE. A CHARGE IS MADE FOR US TO RECOIL AND TAPE CABLES. INSTRUCTIONS ARE AVAILABLE ONLINE, "THE GUIDE BOOK, INSTRUCTIONS AND HOW TO RETURN A HIRE"

32 AMP

10 M
25 M

£ 8.00
£ 15.00

63 AMP

10 M
20 M
35 M

£ 10.00
£ 20.00
£ 35.00



THREE PHASE (63AMP 3 PHASE NEUTRAL AND EARTH)

63 AMP 3PH

10 M
15 M

£ 15.00
£ 25.00

CONTROL CABLE

8 PIN DIN OR DMX

1.5 M
10 M
25 M

£ 0.50
£ 1.00
£ 2.50



NOT TO SCALE!



OCTAL PLUGS AND SOCKETS ARE FOUND ON STRAND MINI 2 RACKS. MOST OTHER ANALOGUE RACKS WILL USE 8 PIN DIN. DMX RACKS WILL BE 5 PIN XLR. SOME DMX IS ON 3 POLE XLR.

ADAPTORS (ALWAYS SPECIFY AS PLUG TO SOCKET)

SMALL I.E 13A TO 15A, 13A TO 16A, 15A TO 13A, 5A TO 15A, 15A TO 5A, 15A TO 16A, 16A TO 15A, IEC TO 15 AMP

£ 2.00

BIG I.E 13A TO 63A, 15A TO 32A, 15A TO 63A, 32A TO 63A. 63A TO 32A

£ 15.00

GRELCO 15 AMP 3 WAY OR 16 AMP 3 WAY

£ 1.25

GRELCO 15 AMP 2 WAY

£ 0.75

13 A 4 WAY SHORT, 2M 4 WAY OR 5M 4 WAY

£ 1.00

13 A 10M

£ 1.00

13 A 25M

£ 2.00

13 A 5M 6WAY INDIVIDUALLY SWITCHED

£ 2.50

OK! I HAVE NOW SWITCHED IT ON. BUT IT'S STILL NOT WORKING.



BARE END ADAPTORS

BARE ENDS TO 32 AMP

£ 10.00

BARE ENDS TO 63 AMP

£ 15.00

BARE ENDS TO 63 AMP 3 PHASE

£ 25.00

2 WAY 63 AMP 1 PHASE SPLITTER

£ 25.00



DISTRIBUTION BOARDS

63 AMP 3 PHASE 3 X 1PH RCD TO 6 X 63 AMP SOCKETS <i>F</i>	£ 90.00
32 AMP 3 PHASE SWITCH FUSE TO 3 X 32 AMP 1 PH SOCKETS	£ 30.00
60 AMP RCD DISTRIBUTION 63 AMP TO A 63 AMP SOCKET	£ 30.00
63 AMP PLUG, BOARD MOUNTED TO 12 X 13 AMP SOCKETS (2 RING MAINS)	£ 30.00

MULTICORE CABLE (15 AMP OUTLETS)

A QUICK AND EASY WAY TO RUN MULTIPLE CABLES TO YOUR LIGHTING. IT SAVES A LOT OF TIME AND EFFORT!
BUT DON'T LEAVE IT COILED UP! AS IT IS AN ELECTRIC MOTOR GOING NOWHERE AND IT WILL BURN OUT!

SOCAPEX	10 M	£ 10.00
	25 M	£ 25.00
MALE SPIDER 6 WAY		£ 10.00
FEMALE SPIDER 6 WAY		£ 10.00
SOCAPEX SPLITTER 2 WAY		£ 10.00
30M 3 WAY MULTICORE		£ 10.00

STANDS ETC (INCL T-BAR WHERE APPROPRIATE)

GROUND STANDS	6"	£ 1.00
LOW STANDS	2'	£ 4.00
LOW STANDS	5'	£ 5.00
STANDARD STANDS (REF49)	14'	£ 10.00
WIND UP STANDS (REF 55)	15'	£ 30.00
FOLLOW SPOT STAND		£ 20.00
STAGE WEIGHT		£ 4.00
STAGE BRACE		£ 5.00
BOOM BASE STANDS	3M' POLE, BASE PLATE AND STAGE WEIGHTS WITH 3 BOOM ARMS	£ 20.00



PROLYTE SQUARE TRUSS

1.5M	£ 15.00
3.0M	£ 30.00
3 WAY CORNERS	£ 15.00
BASE PLATE	£ 10.00
3M CIRCLE TRUSS, TRIANGULAR	£ 150.00

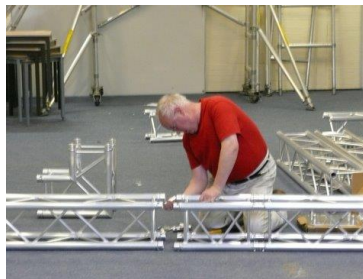

PYROTECHNICS (PLEASE BE CAREFUL WITH PYROTECHNICS)

LE MAITRE	1 WAY	£ 15.00
	2 WAY	£ 20.00
	6 WAY	£ 50.00
CONFETTI CANON		£ 30.00
BOMB TANK		£ 30.00
STANDARD POD (AS AN ADDITIONAL ITEM)		£ 5.00
ANGLE POD (AS AN ADDITIONAL ITEM)		£ 7.50
HAND HELD DOUBLE FLASH GUN		£ 15.00
ALADDIN'S LAMP <small>FLASH COTTON AND PAPER EXTRA</small>		£ 25.00



OVER 18'S ONLY !

I TOLD YOU TO TAKE THE KEY OUT !

PLEASE ISOLATE THE FIRE ALARM ZONE BEFORE USING PYROTECHNICS.

**WHEN BOOKING EQUIPMENT, PLEASE GIVE US SOME NOTICE,
 THE IMPOSSIBLE WE CAN DO AT ONCE.....MIRACLES TAKE A LITTLE LONGER.**



STAGING* TRANSPORT IS AN EXTRA ! SO IS SETTING UP AND REMOVAL !

WHEN WE DELIVER OR COLLECT, THE DRIVER WILL GET THE VEHICLE AS CLOSE AS PRACTICAL. YOU WILL BE EXPECTED TO SUPPLY FIT PEOPLE TO MOVE THE DECK, TO AND FROM ITS PLACE OF USE. IF YOU WOULD LIKE US TO FIT AND REMOVE THE DECK WE WILL SEND A SECOND PERSON. THIS MUST BE ARRANGED AT TIME OF ORDER AND IS CHARGED FOR ACCORDINGLY. STAIRS WILL INVOLVE EXTRA COSTS AND YOU MUST ADVISE US OF THE ACCESS ROUTE AND SITE CONDITIONS. STAGEBASE HAS NORMALLY BLACK TOPS, BUT NOT NECESSARILY SO ! THERE MAY BE SOME WEAR AND TEAR TO THE PAINT FINISH. PLEASE DO NOT PAINT THEM. ALSO, PLEASE DO NOT USE GAFFA TAPE ON OUR DECKS.

STAGEBASE*

2M X 1M
1M X 1M

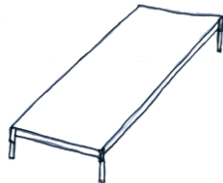

£ 25.00
£ 20.00

PLEASE SPECIFY HEIGHT OF LEGS 12", 18", 24", 30" OR 36". A SET OF STANDARD LEGS ARE INCLUDED IN THE COST OF THE STAGEBASE.

STEPS*

STEPS UP TO 18"
STEPS OVER 18" UP TO 36"



£ 18.00
£ 36.00

IT'S ONLY 30 BITS OF DECK

STAR CLOTH* F

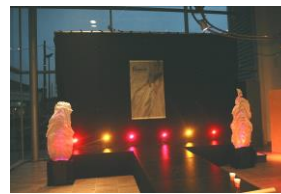

FASHION SHOW

22' x 13' BLACK CLOTH (2) FIBRE OPTIC TWINKLE (WHITE) OR COLOUR CHANGING £ 120.00
SET OF 2 NO WINDUP STANDS AND 6M TRUSS TO SUIT STARCLOTH £ 120.00

CAMOUFLAGE NET*

6 M X 2.4 M CAMO NET 4
12 M X 6 M CAMO NET 1
5 M X 5 M CAMO NET 2



£ 30.00
£ 75.00
£ 25.00

WHEN I SAID "HIDE THE BIN" I MEANT AROUND THE SIDE OF THE BUILDING....

VIDEO WALL* F

VARIOUS SIZES FOR SHOWING SLIDES OR VIDEO ON A GRAND SCALE. AS THERE ARE SO MANY VARIABLES WE WOULD NEED TO DO A SITE VISIT TO QUOTE, **WHICH IS FREE !**



LEAVING IT TO 25 PAST DECEMBER IS A BIT LATEBOOK EARLY TO AVOID DISAPPOINTMENT !

**PLEASE TELL YOUR ACCOUNTS DEPARTMENT THAT WE MOVED TO ROCHESTER IN 2016 !
WE WERE RECENTLY TOLD "YOU HAVEN'T MOVED" DESPITE THE DETAILS ON THE INVOICE.
OUR BANK DETAILS HAVE CHANGED AS WELL SO PLEASE USE THE INFORMATION ON THE INVOICE
WHAT WERE WE ALL TOLD AT SCHOOL ?..... "READ THE QUESTION AND ANSWER THAT ONE"**



SPECTRA TUBES

1M HIGH BATTERY OPERATED IP65 RATING 4-8 HOURS RUNTIME 128 LEDS IN 16 ZONES

WIRELESS DMX

£ 250 PER 10

NUMBERS AND LETTERS

LED LIGHTS INSIDE APP 1.2M HIGH

NUMBERS £50 EACH (2 NUMBERS SAY 24 FOR THE YEAR OR SIMILAR)

LOVE £350

WEDDINGS, PROM AND FASHION SHOWS PACKAGES

**PAGE UNDER CONSTRUCTION
PICTURES TO FOLLOW**



**THANKS TO WESTACRE THEATRE FOR THE PICTURE OF OUR 1955 POLAROID CAMERA TYPE 290
AS USED IN "FIVE LESBIANS EATING A QUICHE"**



MIRROR BALLS* F

N.B. TRANSPORT IS AN EXTRA. NOT FOR OUTDOOR USE !

WE ARE PROBABLY THE MARKET LEADER FOR THE HIRING OF MIRROR BALLS IN THE COUNTRY. ALL OF OUR EQUIPMENT IS TESTED FOR WEIGHT CARRYING CAPACITY, TO BE AS SAFE AS POSSIBLE. THE PRICE INCLUDES ROTATOR WITH 16 AMP PLUG, SAFETY STROP AND A SUSPENSION STROP OF YOUR CHOICE OF 5M, 1M, 1.5M, 2M OR 3M LONG. PLEASE SPECIFY LENGTH WHEN ORDERING. ADDITIONAL STROPS AND ACCESSORIES ARE CHARGEABLE. PLEASE KEEP THE BOXES, EVEN IF IT IS JUST A CARDBOARD BOX ! THE FLIGHTCASES TO REMAIN ON SITE. FIGURES IN BRACKETS ARE OUR USUAL STOCK.

ROTATORS ARE 1 OR 2 RPM AND ARE A NON-DIM ITEM

54" OR 48" (NOMINALLY 4')	AS SEEN ON STRICTLY COME DANCING!FIRST 13 SERIES.	£ 500.00 (2+2)
32"		£ 150.00 (5)
30" HALF MIRROR BALL (FLOOR MOUNT ONLY)		£ 130.00 (2)
24"		£ 90.00 (3)
20"		£ 50.00 (15)
16"		£ 40.00 (12)
20" HALF MIRROR BALL		£ 40.00 (2)
12"		£ 35.00 (12)
8"		£ 30.00 (5)
SPARE ROTATORS (LARGE SIZE & HEAVY DUTY)		£ 40.00
DMX ROTATOR 65KG VARISPEED REVESIBLE	OR ADD £35 TO STANDARD	£ 60.00 (3)
MONOPOLE ADAPTOR (TELEVISION STUDIOS)	OR ADDITIONAL STROPS	£ 6.00
DEKO GOLD 24"	SOON	£ 200.00
DEKO GOLD 20"	SOON	£ 80.00
DEKO GOLD 16"	SOON	£ 60.00
DEKO GOLD 12"	SOON	£ 40.00

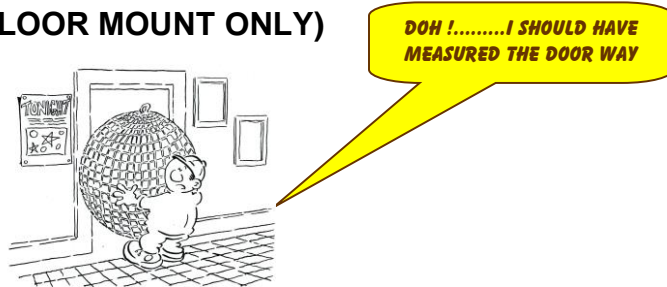

**PLEASE SELECT A MIRROR BALL IN PROPORTION TO YOUR VENUE AND.....
CHECK THE SIZE OF THE ACCESS DOORS AND GET IN ROUTE !**

**SAFETY IS OF THE UTMOST IMPORTANCE ! ONLY USE OUR RIGGING EQUIPMENT ! IT IS LOLER TESTED.
WHEN CONSIDERING TRANSPORT, DON'T FORGET THE SIZE OF THE FLIGHTCASE !
IT'S WORTH ASKING US TO DELIVER, WE TRY TO BE REASONABLE WITH OUR PRICES. FOR 54" OR 48"
MIRROR BALLS, YOU WILL NEED A TAIL LIFT LUTON VEHICLENOT A VAN !.....IT WON'T FIT !**

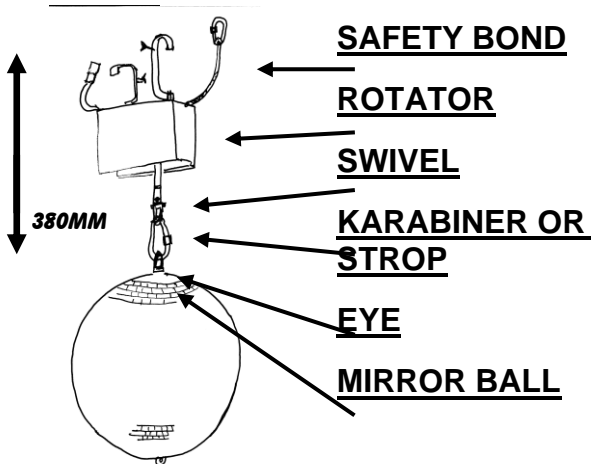

THE COMPLETE ASSEMBLY IS TESTED UNDER LOLER REGULATIONS.

NO UNAUTHORIZED RIGGING EQUIPMENT TO BE USED!

DO NOT REMOVE SAFETY WIRES ON THE SWIVEL. USE THE KARABINER OR STROP TO SUPPORT THE MIRROR BALL.

WHEN RETURNING A MIRROR BALL MAKE SURE IT IS OURS.

OR.....
CAN I TAKE YOUR MERCEDES 600SLK HOME?
AFTER ALL IT HAS ALL THE SAME BITS AS OUR VANS, WHEELS, ENGINE, BRAKES ETC
.....NO I THOUGHT NOT!

BAR TO SWIVEL IS 380mm PLUS YOUR CHOICE OF OUR STROP TO THE BALL.

CASE SIZES

54" - 67" X 56" X 56"

48" - 63" X 52" X 52"

32" - 43" X 37" X 37"

24" - 33" X 28" X 28"

20" - 28" X 24" X 24"

NO, I AM NOT DRAWING ALL THE MIRRORS! A 54" HAS SOME 92,350 MIRRORS @ 8mm SQUARE!

MOST OF OUR MIRROR BALLS HAVE 8MM FACETS.

LARGER FACETS BREAK TOO EASILY IN NORMAL USE AND BECOME DANGEROUS.

BEST THEATRE LANTERN: PROFILE, SOURCE FOUR 19° WITH IRIS OR A SMALL LENSED MOVING LIGHT.

MIRROR BALL HIRES ARE PREPARED A DAY OR TWO IN ADVANCE, DON'T LEAVE IT TO THE LAST SECOND!. ONE CUSTOMER SAID

"I WANT A 48" IN LONDON **TONIGHT**", DAVID "CERTAINLY, WHO FOR ?" CUSTOMER "DAME SHIRLEY BASSEY!"

JUST HOW LONG AGO WAS THAT BOOKING MADE ?

CAN WE MAGIC UP ANOTHER ONE IF YOU LEAVE IT TOO LATE ?..... NO !



SOUND *

MICS AND RADIO MICS ARE JUST THAT AND YOU WILL NEED A MIXER, AMP AND SPEAKERS FOR SOUND.

RADIO MICROPHONES AND MICROPHONES ETC

TRANTEC VHF TIE CLIP OR HAND HELD	£ 90.00
JTS UHF TIE CLIP RADIO MIC OR HEAD BAND (NOW IN BLACK OR BEIGE)	£ 90.00
OUR UHF RADIO MICS ARE FLIGHTCASED IN MULTIPLES OF 4, INCLUDES MIC BELT POUCHES, BATTERIES ETC	
RADIO MIC BELT POUCH (TO FIT UNDER COSTUME) INCLUDED WITH OUR MICS	£ 5.00
HAND HELD VOCAL MIC, SHURE SM 58 OR 1950'S STYLE MIC INCL 10M XLR	£ 15.00
AUDIO TECHNICA OR MAXI "GUN" MIC INCL 10M XLR	£ 20.00
MINI GUN MIC OR OVERHEAD MIC CM504 (REQUIRES PHANTOM POWER)	£ 15.00
CAR SYSTEM WITH MIC (CIGAR LIGHTER PLUG)	£ 30.00
30M MULTICORE 24 WAY + 4 RETURNS	£ 32.00
30M MULTICORE 4 WAY	£ 20.00
15M 7 WAY MULTICORE	£ 15.00
SINGLE PHANTOM PSU / D.I. BOX (FOR INSTRUMENTS)	£ 7.00
SOUND EFFECTS CD'S FROM OUR LIBRARY	£ P.O.A.

A QUARTER TURN OF THE SPEAKON PLUG, NOT YOU!

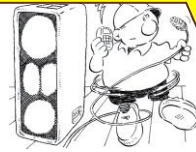

WE RECOMMEND WITH EACH HIRE THAT YOU CHANGE THE BATTERIES IN RADIO MICS EVERY PERFORMANCE. WE INCLUDE PROFESSIONAL BATTERIES WITH EACH HIRE, . WE SUPPLY YOU WITH THE BATTERIES YOU WILL NEED AS WE DO NOT LIKE "CHEAP" BATTERIES... AS "NASTY" OFTEN FOLLOWS. THEY WILL LEAK ! DON'T MIX USED AND NEW.....

DFS TROLLEY SYSTEM F' (ALL IN ONE)

NO 1. TROLLEY MOUNTED, 12+4 MIXER, 600 WATT AMP, 4 SPEAKERS & STANDS, 2 CD, 4 RADIO MICS 4 GUN MICS AND ALL THE CABLES	£ 600.00
NO 2. TROLLEY MOUNTED, 12+4 MIXER, 800 WATT AMP, 2 SPEAKERS & STANDS, 2 CD PLAYERS AND ALL THE CABLES	£ 250.00

STANDS

MIC BOOM STAND	£ 5.00
MIC STRAIGHT OR ROUND BASED STAND	£ 5.00
MIC TABLE STAND	£ 2.00
SPEAKER STAND	£ 5.00

AMPLIFIERS

250 WATT PRL250	£ 20.00
300 WATT PRL600	£ 30.00
600 WATT YAMAHA	£ 45.00

MIXERS

12 MIC CHANNEL F'	£ 48.00
18 MIC CHANNEL 2 STEREO	£ 60.00



NOW THAT YOU HAVE FINISHED, WE HAVE A VISITING T.I.E. COMPANY COMING IN TOMORROW, YOU DON'T MIND IF WE ALTER ALL YOUR LIGHTS DO YOU ?

LOUDSPEAKERS (PRICES PER PAIR INCL 25M CABLE TO EACH SPEAKER)

CARLSBORO 200 WATT	£ 40.00
PEAVEY 300 WATT	£ 40.00
PROEL TFL10 200 WATT	£ 40.00
POWERED FOLDBACK WEDGES (JACK INPUT)	£ 40.00

CD PLAYER (INCL PHONO TO JACK ADAPTOR) **F'**

CD PLAYER	£ 30.00
-----------	---------



SPEECH DAY / CONFERENCE SYSTEM

PASSPORT SYSTEM 250 WATT COMBINED AMPLIFIER, MIXER AND SPEAKERS WITH 2 CABLED MICROPHONES	£ 100.00
AND <u>FACILITIES</u> FOR 2 MORE MICROPHONES, ALSO CD ETC (AT EXTRA COST)	

WE ALSO OPERATE FOR SHOWS AND EVENTS SUCH AS PUBLIC MEETINGS, PLEASE ENQUIRE.



PROPS AND HANDHELD PROPS*

PLEASE SELECT THE PROPS APPROPRIATE TO THE ERA OF YOUR PRODUCTION.

ANIMALS	FAKE OF COURSE! CARRIAGE IS EXTRA !		TYPE	QUANTITY	PRICE EACH PER WEEK
ASSES HEAD RUBBER MASK- SALES (A MIDSUMMER NIGHT'S DREAM)			781	AS	£28.00
BIRDCAGE - EMPTY OR WITH COCK LINNET			497	1	£8.00
DEAD DUCK AND SACK (BEAUTY AND THE BEAST)			742	1	£8.00
GOOSE WITH GOLDEN EGG D			663	1	£15.00
OWL ON PERCH			457	2	£15.00
PARROT 500MM			404	1	£10.00
PARROT CAGE INCL PARROT			403	1	£20.00
PIGEON CAGE - EMPTY (THEY'VE FLOWN HOME)			726	3	£10.00
RAT - FURRY			458	14	£3.00
TIGERS HEAD, WALL MOUNT TROPHY D			662	1	£20.00
					
		"OI, WHERE'S ME TIGERS HEAD..... 4' FROM HIS TAIL"			
CAMERAS	ALL ARE NON PRACTICAL, SOME FLASH (NOTED) FLASH LAMPS EXTRA !				
1980'S PRESS CAMERAS, FLASHES, "PAPARAZZI"			459	31	£15.00
1930's STYLE HAND CRANK FILM CAMERA ABSOLUTE FAKE !			912	1	£40.00
500MM LENS FOR M42 MOUNT, CAMERA EXTRA			812	1	£25.00
AA CAMERA 110 / INSTAMATIC			454	4	£10.00
AGFA BILLY CAMERA 1930'S MINT CONDITION			898	1	£20.00
AGFA ISOLETTE 1 CAMERA CAN FLASH USE 834			198	3	£10.00
ARGUS 1950'S CAMERA /FLASH. FLASH LAMP £ 10.00 EA			807	3	£40.00
BABY GRAPHLEX CAMERA D FLASH LAMP £ 10.00 EA			327	5	£ 100.00
BAKELITE CAMERA WOOLWORTHS D			282	1	£10.00
BALDA CAMERA D			263	1	£10.00
BAUER 88R CINE CAMERA			827	1	£15.00
BELLAND HOWELL 16MM CINE CAMERA 1950'S CLOCKWORK			889	1	£20.00
BOOTSAMICA CAMERA KIT INCL LENS AND FLASH			811	1	£30.00
BROWNIE HAWKEYE			194	1	£10.00
BROWNIE SIX20			192	2	£10.00
CAMERA CASE 1940'S LEATHER -EMPTY			788	1	£15.00
CAMERA CASES EMPTY 1960'S - BE AN AMERICAN TOURIST!			804	24	£5.00
CAMERA FLASH ONLY- COLD SHOE. FLASH LAMP £ 6.00 EACH			834	5	£8.00
CAMERA FLASH ONLY- HOT SHOE.			803	5	£8.00
CANON CINE CAMERA			630	1	£12.00
COMPACT FLASH CAMERAS			680	2+	£10.00
CONTESSA NATTEL PICCOLLETTE 1930'S			822	1	£35.00
CORONET BOX CAMERA 1930'S			907	1	£10.00
CORONET FOLDING CAMERA WW2			193	1	£10.00
COSINA CT1 CAMERA AND FLASH- KIT D			644	1	£30.00
EMPIRE SCOUT CAMERA D			253	1	£10.00
ENSIGN MIDGET CAMERA 1934 D			328	1	£10.00
ENSIGN ROSS SUPER FUL-VUE 1954-1959			835	1	£10.00
FAKE TELEVISION CAMERA AND BOOM MIC - DOING HAIRSPRAY ?			456	1	£30.00
AGFA RECORD CAMERA 1951 D			455	1	£10.00
FEX CAMERA			222	1	£10.00
FLASH GUN 1970'S #			230	1	£10.00
FLASH BANG WALLOP CAMERA 6 FLASH, FLASH £ 10.00 EACH			229	4	£50.00
FRENCH BELLOWS CAMERA			196	1	£10.00
HAND CRANK FILM CAMERA 1920'S - FAKE !			782	1	£30.00
FUJIKI CINE CAMERA			212	1	£15.00
HALINA CAMERA D CAN FLASH USE 834			255	1	£10.00
HANAY 35 CAMERA 1960'S CAN FLASH USE 834			784	1	£10.00
ILFORD SPORT CAMERA D CAN FLASH USE 834			268	2	£10.00
ILOCA CAMERA D			290	1	£10.00
KODAK 127			623	1	£10.00
KODAK COLOURSNAP 2 CAMERA D			262	1	£10.00
KODAK DUAFLEX 2 CAMERA D			298	1	£10.00
KODAK EK300 INSTANT CAMERA			809	1	£15.00
KODAK INSTAMATIC			605	2	£10.00
					
		ARGUS			
					
		GRAFLEX			
					
		TYPE 912			
					
		TYPE 229			
		HOLD IT, FLASH, BANG WALLOP..... OR WHEN WE ARE MARRIED ?			



	TYPE	QUANTITY	PRICE EACH PER WEEK
KODAK NO 3 CAMERA D		300	1 £10.00
KODAK RETINETTE D CAN FLASH USE 834		254	1 £10.00
KODAK SIX20 C D		264	1 £10.00
KODAK STARMATIC CAMERA		221	1 £10.00
KODAK VECTRA CAMERA D		261	1 £10.00
LECINA CINE CAMERA		219	1 £15.00
MINIATURE SPY CAMERA D		325	1 £10.00
MINATURE KIEV SPY CAMERA D		324	1 £10.00
MINOLTA 7000i CAMERA KIT INCL LENS & FLASH		810	1 £30.00
NIKON SLR PROFESSIONAL CAMERA KIT		796	1 £30.00
OLYMPUS TRIP CAMERA / FLASH D FLASHES		271	1 £15.00
PANASONIC M40 CINE CAMERA VHS 1980'S		966	1 £40.00
PETRI SLR CAMERA KIT D		797	1 £30.00
PICTURE VIEWER		794	1 £10.00
POLAROID LAND CAMERA D		270	1 £10.00
POLAROID SPEED LINER 1955 D 1957 INTO 1960'S FLASHES		291	3 £40.00
POLAROID LAND CAMERA MODELS 215, 320 AND 104 1965-1969 D		756	2 £15.00
POLAROID STUDIO CAMERA 4 SHOT FOR PASSPORT PHOTOS ETC FLASHES		868	1 £25.00
POLAROID SWINGER 1967		197	1 £10.00
POLAROID VISION 90 1990'S CAMERA		805	1 £10.00
PRAKTIKA CAMERA WITH FLASH		778	3 £15.00
PRAKTIKA CAMERA KIT		833	1 £30.00
SHACKMAN PASSPORT CAMERA D		311	1 £15.00
SONY PROFESSIONAL VIDEO CAMERA 1980'S PRACTICAL		735	1 £40.00
THORNTON PICKARD STUDIO CAMERA & TRIPOD 1940'S		790	1 £50.00
TRIPODS - MODERN		767	11 £10.00
UNDERWATER CAMERA		808	2 £15.00
YASHICA C CAMERA D		297	1 £15.00
YASHICA CINE CAMERA		191	1 £15.00
ZENIT SNAIPER 12 SOVIET SPY CAMERA 1974-1982		824	2 £40.00
ZENIT 3M CAMERA D		900	1 £10.00
ZORKI 4-K CAMERA AND FLASH D FLASH LAMP £ 6.00 EACH		259	1 £15.00
CANDELABRA BATTERY OPERATED			
3 BRANCH CANDELABRA SILVER		13	4 £18.00
5 BRANCH CANDELABRA		12	1 £20.00
5 BRANCH ORNATE BRASS CANDELABRA		60	1 £25.00
5 BRANCH SILVER CANDELABRA		461	2 £22.00
BRASS 4 BRANCH CANDELABRA		943	1 £25.00
FLOOR MOUNT CANDELABRA, MAINS		42	5 £25.00
IRON CANDELABRA - LARGE CANDLES		940	2 £25.00
WALL MOUNTED CANDLE SCONCE 3 BRANCH		939	4 £25.00
CANDLES BATTERY OPERATED			
CANDLESTICK		639	2 £10.00
CHURCH CANDLES 6' TALL MAINS OPERATED		386	2 £15.00
HAND HELD CANDLE		1	44 £6.00
LARGE HAND HELD CANDLE		63	12 £10.00
MENORAH		567	1 £22.00
CANDLE STICK - SINGLE 6 BRASS, 6 SILVER, 2 DOUBLE 5 SMALL		7	6+6+5+2+2 £10.00
CANDLE STICK - SHORT		938	2 £12.00
CANDLE STICK - TWISTED		8	2 £10.00
NOT SO WEE-WILLIE-WINKIE		937	1 £15.00
WEE WILLIE WINKIE		2	18 £10.00
WEE WILLIE WINKIE LARGE		85	12 £10.00
WEE WILLIE WINKIE ORNATE		3	17 £10.00
WEE WILLIE WINKIE WITH HANDLE		283	3 £10.00
WEE WILLIE WINKIE WITH REFLECTOR		407	1 £10.00
WEE WILLIE WINKIE WOODEN		356	1 £10.00
WOODEN CANDLESTICKS 24" WITH 5" X 3" CANDLES		668	2 £12.00



**TYPE 291
POLAROID 1960'S**



RUBY REFLEX



ZENIT SNAIPER 12



TYPE 386



TYPE 3



CHANDELIERS

3 LAMP CHANDELIER C
 4 BRANCH CHANDELIER
 4 BRANCH SILVER CHANDELIER
 8 BRANCH CHANDELIER BRASS
 8 BRANCH BRASS & GLASS CHANDELIER
 8 BRANCH CHANDELIER BRASS
 12 BRANCH BRASS CHANDELIERS
 CHANDELIER (SAC Á PERLES)



TYPE 654

TYPE	QUANTITY	PRICE EACH PER WEEK	
	49	1	£15.00
	91	1	£18.00
	353	1	£20.00
	187	1	£30.00
	188	1	£30.00
	813	2	£30.00
	654	2	£40.00
	590	2	£25.00

ELECTRIC PROPS

2 ARM WALL SCONCES 4 BLACK, 4 BRASS
 3 BRANCH GLASS BOWL LIGHT
 ART DECO GLASS WALL LIGHT
 ART DECO TABLE LAMP
 BANKER'S TABLE LAMP
 BFG BOTTLES OF DREAMS
 BRASS WALL FITTING
 BRASS WALL FITTING C
 BRASS WALL FITTING 1970'S
 FIREPLACE, OLD WHITE, APPROPRIATE FIRE INCLUDED OR BLACK SURROUND
 FOOTLIGHTS - SHELL - 1M SECTIONS OF 3 LAMPS
 GEIGER COUNTER
 LAMPOST, 3 @ 2.4M, (SMALL) 2 4.3M, 4.5M (LARGE)
 LARYNGOSCOPE
 MINERS TORCH 1970'S BATTERY OPERATED
 NEW 'PUP' FILM LIGHT ON WHEELED STAND
 "ON AIR" SIGN
 ONYX TABLE LAMP 1950/60'S
 PLAFONIER 1930'S (LAMP SHADE)
 REMOTE SWITCH FOR LANTERNS
 SNCF TORCH 1970'S
 SNCF LANTERN
 STANDARD LAMP- 1970'S
 SUNSPOT PATT 501 CARBON ARC FOLLOW SPOT
 TABLE LAMPS - OVAL SHADE D
 TIFFANY LAMP SS
 TORCH 1950S - 1960S METAL BODY BATTERY
 TORCH, 1970'S CAMPING TYPE
 TORCH 1980'S - TODAY, RAILWAY WHITE GREEN RED FILTERS, SUPER BRIGHT

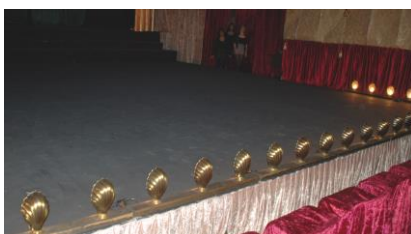

**PATT 501 SUNSPOT 1930'S
 CARBON ARC
 FOLLOW SPOT**

	347	4 + 4	£10.00
	345	2	£15.00
	432	2	£15.00
	368	1	£15.00
	444	2	£15.00
	184	SET/3	£27.00
	89	4	£10.00
	55	2	£10.00
	90	4	£10.00
	490	1+1	£45.00
	385	24	£20.00
	897	1	£50.00
	94	3 S, 2 L	£ 30.00 / £40.00
	496	1	£25.00
	83	1	£10.00
	645	3	£30.00
	718	1	£20.00
	426	1	£10.00
	920	1	£18.00
	793	5	£10.00
	226	1	£10.00
	40	1	£10.00
	492	2	£15.00
	899	2	£ 1000.00
	919	2	£10.00
	510	1	£10.00
	583	12	£5.00
	250	12	£5.00
	731	3	£12.00

FIRES AND FLAMBEAUX *PLEASE ASK FOR A FULL PICTURE BROCHURE*

1940S ELECTRIC FIRE, MOST LIGHT UP
 1950'S ELECTRIC FIRE, LIGHTS UP
 BRASS FIRE GUARD KIT
 BRAZIER CHOICE OF 3, 1 MAINS, 2 BATTERY
 COAL FIRE AND DRESSING
 COPPER AND BRASS FIRE TOOLS
 COPPER FIRE 1930'S, LIGHTS UP
 FIRE - BELLING 1970'S, LIGHTS UP
 FIRE - SMALL 1950'S, LIGHTS UP
 LOG FIRES LARGE
 LOG FIRES SMALL
 GAS FIRE (LED)
 WITCH'S CAULDRON AND FIRE **NEW VERSION !Doing "The Scottish Play" ?**
 HAND HELD FLAMBEAUX SILVER BATTERY OPERATED
 FLAMBEAUX POLE MOUNT



	649	4	£15.00
	418	1	£15.00
	463	1	£8.00
	44	1+1+1	228.00
	251	1	£30.00
	508	1	£10.00
	417	1	£15.00
	602	1	£15.00
	604	2	£15.00
	47	1	£30 / £35
	464	2	£25.00
	931	1	£15.00
	46	1	£50.00
	28	5	£22.00
	620	2	£25.00



PRICE EACH
PER WEEK

	TYPE	QUANTITY	PRICE EACH PER WEEK
MEDIEVAL FLAMBEAUX POLE MOUNT	43	8	£25.00
WALL MOUNTED FLAMBEAUX	256	2	£18.00
WALL MOUNTED FLAMBEAUX	257	2	£18.00
WALL MOUNTED FLAMBEAUX	689	2	£18.00
WALL MOUNTED CANDLE FLAMBEAUX	688	2+2+4	£18.00

FLOWERS

ASPIDISTRA INCL COLUMN	491	2	£15.00
BASKET OF 'FLAHS IN BUNCHIS'	498	1	£15.00
PURPLE FLOWER (A MIDSUMMER NIGHT'S DREAM)	878	8	£2.00
DEAD FLOWERS AND JUGS – LITTLE SHOP OF HORRORS	963	1 SET 4	£30.00
ROSES – BASKET (36)	175	3	£15.00
ROSES BOUQUET	554	1	£10.00
ROSES/TULIPS – BASKET	438	1	£15.00
ROSES PINK BUNCH OF 12	848	4	£12.00
ROSES WHITE BUNCH OF 12	849	2	£12.00
ROSES WHITE / YELLOW BUNCH OF 12	847	2	£12.00



FOOD

ALL FAKE, SO NOTHING WASTED !

APPLE – LARGE GREEN	96	12	£0.50
APPLE – LARGE RED	98	6	£0.50
APPLE – SMALL GREEN	95	36	£0.50
APPLES AND PEARS	529	30	£0.50
APPLES AND PEARS – BASKET	335	1	£12.00
APPLES – TRAY (A)	112	2	£15.00
ASPARAGUS – BASKET	314	1	£12.00
ASPARAGUS – BUNCH (6)	120	6	£0.50
ASPARAGUS – PLATTER	484	2	£8.00
AUBERGINES – BASKET	236	1	£15.00
AVACADO	871	12	£1.00
BAGUETTE (2)	127	2	£8.00
BANANA	103	23	£0.50
BASKETS – VARIOUS	468	12	£10.00
BEANS – PLATTER	316	1	£8.00
BEEF AND POTATO PLATTER	140	2	£12.00
BISCUITS – PLATTER	318	1	£12.00
BIG BLUE FISH	533	1	£10.00
BOARS HEAD PLATTER A	186	2	£15.00
BREAD BASKET	165	1	£15.00
BREAD BASKET	319	1	£15.00
BREAD BASKET	126	1	£5.00
BREAD BASKET OVAL	164	2	£10.00
BREAD – SMALL BASKET	180	1	£5.00
BREAD – BASKET WHOLEMEAL	181	1	£5.00
BREAD ROLLS–SET 12 ALLO, ALLO ?	577	1 LOT 12	£8.00
BREAD ROLLS – BASKET	266	1	£8.00
BREADS – TRUG	166	1	£15.00
BREAM (4)	534	1 LOT	£12.00
BROAD BEANS – BASKET	483	1	£5.00
BUNS AND TRAY CALENDAR GIRLS	699	1	£25.00
CABBAGE – TRAY	441	1	£15.00
CABBAGE – TRUG A	114	1	£15.00
CARROTS – LOOSE – BASKET	544	1	£10.00
CARROTS	123	24	£1.00
CARROTS – PLATTER	439	2	£8.00
CAULIFLOWERS – BASKET	440	1	£15.00
CAULIFLOWERS SMALL, LOOSE	525	12	£1.00
CHEESE – BASKET	162	1	£12.00
CHEESE BOARD	150	2	£10.00



MEDIEVAL BANQUET ?



TYPE 185



CHERRIES – BASKET
 CHICKEN – HALF EATEN
 CHICKEN & SPUDS PLATTER
 CHOCOLATE CAKE
 CHOCOLATE CAKE –FRUIT CAKE- LARGE
 CHRISTMAS PUDDING
 CLAM SHELLS – TRAY
 CORN ON THE COB – SMALL PLATTER
 CORNUCOPIA OF FRUIT
 COURGETTES AND PEPPERS – BASKET
 COURGETTES / GARLIC – BASKET
 CRAB PLATTER
 CRABS (6) IN BASKET
 CUCUMBER / GERKINS (3)
 DOVER SOLE (12)
 EDAM CHEESE 2 ON STRING
 EGGS – BASKET OF 12
 EGGS – BASKET OF 12
 EGGS – LARGE BASKET
 EXOTIC VEG – BASKET
 FISH HALF EATEN + 3 WHOLE FISH
 FISH AND CLAMS – BASKET
 FISH - BIG - RUBBER
 FISH - BIG BLUE
 FRANKFURTERS TRAY OF 30
 FRENCH STICKS – BASKET OF 4
 FRIED EGGS – PLATTER
 FRUIT – BASKET
 FRUIT – BASKET
 FRUIT – LARGE BASKET (24)
 FRUIT – SMALL BASKET (10)
 FRUIT FLAN
 FRUIT KEBABS 2 X 4 STICKS
 FRUIT - MIXED PLATTER A
 FRUIT PLATTER
 FRUIT PLATTER
 FRUIT PLATTER
 GARLIC / ONIONS 6 STRINGS GARLIC, 12 ONIONS
 GRAPES – BASKET
 GRAPES – BASKET
 GRAPES – BASKET A
 GRAPES – RED BUNCH
 GRAPES – WHITE BUNCH
 GRENADINES – BASKET
 GRENADINES – RIPE – BASKET
 GREY MULLET (12)
 IBERICO HAM – LEG
 KIWI FRUIT
 KIWI – BASKET
 LEMON
 LETTUCE – SMALL – BASKET (20)
 LIMES – BASKET
 LOAF – LONG TIN IN BASKET
 LOAF OF BREAD (OVAL) – BASKET
 LOBSTER PLATTER
 MARKET BARROW FULL OF FRUIT AND VEG (EMPTY £30.00)
 MANGO



TYPE 828



TYPE 237



TYPE 235



FOOD GLORIOUS FOOD ? NO, IT'S PLASTIC



WHO WILL BUY ?

TYPE	QUANTITY	PRICE EACH PER WEEK	
	135	2	£10.00
	485	1	£15.00
	182	1	£15.00
	398	1	£12.00
	828	2	£15.00
	487	2	£10.00
	442	1	£10.00
	130	2	£8.00
	237	4	£15.00
	241	1	£15.00
	338	1	£10.00
	142	1	£15.00
	537	1 LOT	£15.00
	122	6	£0.50
	535	1 LOT	£12.00
	657	1	£10.00
	154	1	£10.00
	125	1	£10.00
	169	1	£10.00
	331	1	£15.00
	527	1	£10.00
	411	1	£12.00
	958	1	£10.00
	533	1	£10.00
	542	1	£12.00
	341	1	£15.00
	209	1	£10.00
	157	1	£10.00
	388	1	£12.00
	108	1*	£12.00
	107	1*	£5.00
	109	2	£15.00
	342	1	£5.00
	110	1	£15.00
	143	3	£15.00
	156	1	£15.00
	170	1	£15.00
	248	6+12	£1.00
	138	1	£10.00
	235	1	£15.00
	246	1	£15.00
	113	1	£10.00
	134	34	£1.00
	133	200	£1.00
	243	1	£8.00
	244	2	£8.00
	536	1 LOT	£12.00
	925	1	£12.00
	136	12	£0.50
	159	1	£10.00
	104	12	£0.50
	545	1	£15.00
	240	1	£8.00
	128	3	£5.00
	129	3	£5.00
	141	1	£15.00
	929	2	£120.00
	853	12	£1.00



	TYPE	QUANTITY	PRICE EACH PER WEEK
MUSHROOMS –WILD – BASKET		176	1 £8.00
MUSHROOMS ETC – BASKET		334	1 £15.00
MUSHROOMS – PLATTER		384	1 £10.00
ORANGE – LARGE		106	12 £0.50
ORANGE – SMALL		105	24 £0.50
PAPAYA – BASKET		203	1 £12.00
PARMA HAM		540	4 £12.00
PEACH		102	6 £1.00
PEAR – GREEN		100	18 £1.00
PEARS – BASKET		173	1 £10.00
PEPPERS – BASKET		158	1 £12.00
PEPPERS – BASKET		312	1 £15.00
PEPPERS – GREEN(3)		118	6 £1.00
PIES – TRAY OF, FOR SWEENEY TODD ETC		579	1 £15.00
PINT OF BEER – RESIN BUT LOOKS REAL !		872	1 £10.00
PHEASANTS (BRACE OF)		641	1 £18.00
PINEAPPLE		869	12 £ 5.00
PLUMS – BASKET		206	2 £8.00
PORK CHOPS, HYPER REALISTIC		548	2 £5.00
POTATOES – BASKET		242	1 £15.00
PRAGUE HAM		541	1 £12.00
PRAGUE HAM AND TOMATO PLATTER		148	1 £15.00
PRETZELS – BASKET		163	1 £5.00
PRAWN COCKTAIL PLATTER		765	1 £15.00
QUAIL – PLATTER OF 3		569	1 £15.00
RADISHES – BUNCH (2)		119	6 £0.50
RED MULLET – PLATTER		155	1 £15.00
RED MULLET PLATTER		144	2 £15.00
PEPPERS – RED (3)		116	6 £1.00
RIB OF BEEF – PLATTER A		115	1 £15.00
ROAST CHICKEN PLATTER		340	1 £15.00
ROAST POTATOES (3)		124	3 £0.50
ROAST POTATOES – PLATTER A		111	1 £15.00
ROOT VEG – MEDIUM BASKET		333	1 £15.00
SACKS OF VEG BEETROOT, TURNIPS, POTATOES		710	6 (2 OFF EACH) £18.00
SALAMIS – BASKET		160	1 £12.00
SALAMIS – BASKET		171	1 £15.00
SALAMIS – PLATTER		161	1 £15.00
SALAMI SAUSAGE (‘ALLO, ‘ ALLO)		562	LOT 2 £10.00
SANDWICHES – PLATTER		233	1 £10.00
STRING OF SAUSAGES		392	10,1M 2, 2M 1, 8M £5, £8, £28
SEAFOOD – PLATTER		177	1 £15.00
SQUASH – BASKET		205	1 £12.00
SQUASH – LOOSE GREEN		854	8 £1.00
SQUASH – LOOSE ORANGE		855	6 £1.00
STAR FRUIT – BASKET		202	1 £12.00
STEAKS (RAW) – BASKET		168	1 £10.00
STEW PACK		247	1 £15.00
STRAWBERRIES – BASKET		137	5 £15.00
STRAWBERRIES – LOOSE (12)		132	2 £0.50
STRAWBERRIES – PUNNET, HYPER REALISTIC		131	6 £5.00
SUNDAY LUNCH BEEF PLATTER		139	1 £15.00
SWEETS FAKE, HANSEL AND GRETEL		614	SET £15.00
T BONE STEAK HYPER REALISTIC		547	2 £5.00
TARTE TARTIN		178	2 £8.00
TOMATOES – BASKET		234	1 £15.00



LANTERNS

ALDIS SIGNALLING LAMP	79	2	£15.00
BRASS LANTERN	352	1	£10.00
BRASS LANTERNS – SMALL	446	2	£10.00
BULLS EYE LANTERN	21	1	£10.00
BULLS EYE LANTERN	665	1	£10.00
BULLS EYE LANTERN – SUPER BRIGHT LED	633	1	£15.00
BULLS EYE BIKE LAMP SUPER BRIGHT LED	701	2	£12.00
BULLS EYE BIKE LAMP SUPER BRIGHT LED	981	1	£20.00
BRASS CANDLE LANTERN	227	1	£10.00
CAROL SINGER LANTERN	16	24	£10.00
CARRIAGE LANTERN	22	2	£10.00
CARRIAGE LANTERN – BRASS	32	1	£10.00
CARRIAGE LANTERN – SMALL	23	2	£10.00
DARK LANTERN	26	4	£10.00
DAVY LAMP	61	3	£10.00
GARDEN LANTERN MAINS	15	1	£10.00
HALLOWEEN PUMPKINS	642	8	£10.00
HANGING LANTERN MAINS 1930'S	84	1	£15.00
HANGING LANTERN – SQUARE C	52	1	£15.00
HAND HELD LANTERN – LARGE	635	1	£15.00
MARINE LAMP	24	1	£10.00
MORROCAN LANTERNS	396	4	£10.00
MORROCAN LANTERN BRASS	930	7	£10.00
MOROCCAN LANTERN – MAINS	578	1	£10.00
MAROCCAN LANTERNS LARGE IRIZAR	947	6	£15.00
MARROCAN LANTERN CANDLE	948	12	£10.00
NIGHT WATCHMAN'S LANTERN	348	1	£10.00
NIGHT WATCHMAN'S LANTERN – SUPER BRIGHT	349	1	£20.00
RAILWAY LANTERN	34	3	£15.00
RAILWAY LANTERN	35	1	£15.00
RAILWAY LANTERN	82	1	£12.00
RAILWAY LANTERN – HAGRID STYLE	37	1	£25.00
RAILWAY LANTERN – BRASS	36	1	£10.00
ROUND HANGING LANTERN	81	12	£10.00
ROUND HANGING LANTERN C MAINS	53	1	£15.00
SHIP'S LANTERN – 1 RED, 1 GREEN MAINS	25	2	£15.00
SHIP'S LANTERN – 1 RED, 1 GREEN HH BATTERY £10 EACH OR £15 THE PAIR	683	2	£10.00
SQUARE SIGNAL LAMP	57	1	£10.00
SNCF LANTERN (SOCIÉTÉ NATIONAL DES CHEMINS DE FER)	40	1	£10.00
SNCF LANTERN	200	1	£10.00
SQUARE LANTERN – SMALL	17	1	£10.00
STORM LANTERN	19	4	£10.00
STORM LANTERN – BLACK	4	21	£10.00
STORM LANTERN (OLD) – FRENCH	10	10	£15.00
STORM LANTERN – FRENCH	18	2	£10.00
STORM LANTERN – GIANT	11	2	£15.00
STORM LANTERN – PLAIN	5	4	£10.00
STORM LANTERN – LARGE	9	5	£10.00
STORM LANTERN – ROUND	41	2	£10.00
SMALL STORM LANTERN	33	8	£10.00
TRAWLER LANTERN	6	8	£10.00
TRAWLER LANTERN SILVER	228	1	£10.00
TRIANGULAR LANTERN	632	1	£10.00



TYPE 34



TYPE 349



TYPE 1029



TYPE 10

ALL HAVE FLICKER CANDLES BUILT IN



LIGHT FITTINGS

COOLIES
 COPPER OIL LAMP
 HAND HELD OIL LAMP
 HANGING OIL LAMP MAINS
 HANGING OIL LAMP C MAINS
 OIL LAMP 5 BATTERY, 2 MAINS
 PEWTER OIL LAMP
 TABLE OIL LAMP
 TALL OIL LAMP MAINS



TYPE	QUANTITY	PRICE EACH PER WEEK
	702	8 £20.00
	39	2 £10.00
	59	1 £10.00
	190	2 £18.00
	50	1 £15.00
	31	5 + 2 £25.00
	38	3 £10.00
	320	1 £10.00
	93	1 £10.00

MISCELANEOUS

ACCORDION
 ALTHIMETER
 AMERICAN FLAG SET – ANNIE
 ASHTRAYS
 ARMCHAIRS, RED LEATHER 1 DFS 2 EP
 BAGPIPES JUNIOR SIZE
 BASKET – LAUNDRY, THEATRICAL SKIP
 BARRELS - PLASTIC VARIOUS SIZES – 10 SMALL 5 LARGE



	558	1 £30.00
	380	1 £10.00
	773	1 SET £20.00
	556	SEV FROM £2.00
	743	3 £50.00
	891	1 £10.00
	759	3 FROM £ 10.00
	305	15 £20.00

BED PAN – ENAMEL **DON'T EVEN THINK ABOUT ITTOO LATE. !**
 BED WARMER

BESOM / CORN BROOMS

BICYCLE 1940'S DUTCH LADIES BIKE, ONIONS ?

BINOCULARS 1930'S SMALL FIELD GLASSES D

BINOCULARS 12 X 80 D

BODY PARTS – FAKE! £15 THE LOT OR £4 EACH

BOOKS – STACK OF 3 BOOKS + WHITE £5 NOTE

BOOKS – LARGE

BOOKS OLD - SOME LEATHER BOUND TYPE ETC

BOSUN'S WHISTLE

BUCKETS AND SCRUBBING BRUSHES

BUGLE

BUGSY MALONE CAR

BUNTING – OLD300M PLUS

BUNTING- UNION JACK 66' (20m) 50 FLAGS

BUST - **STEADY!**

CALLING CARD TRAY

CANDY CANES (PAIR)

CANVAS BAG AND BASEBALL BAT- BLOUSY IN BUGSY MALONE

CANVAS BODY,.....YOU TO DRESS HIM !ARSENIC AND OLD LACE ?

CAR HORN – TOAD'S, POOP ! POOP !

CARDS – FRENCH PLAYING CARDS - 'ALLO, 'ALLO ?

CASES 1930'S-1950S 15 EARLY , 4 LATE

CARPET BEATER

CHAIN AND PADLOCK-PLASTIC – DEMON HEADMASTER

CHAIRS – RUSTIC - THE CRUCIBLE ?

CHIMNEY SWEEPS BRUSHES

, BUNDLES

CLAPPER BOARD

CIGARETTE PACK 1940S – VARIOUS A

CLOCK – MANTLE

CLOCK – ART DECO – WITH GARNITURE (ENDS) D

COCKATOO AND CAGE - 'ALLO,'ALLO

COFFIN - SMALL AND LARGE

COIN PURSES (4 BLACK LEATHER, 2 RED CLOTH)



TYPE 850

	599	1 £8.00
	581	1 £5.00
	697	6 £5.00
	922	1 £25.00
	566	4 £12.00
	265	3 £12.00
	594	4 £15.00
	366	3 £5.00
	518	10 £10.00
	520	36 + £3.00
	495	1 £8.00
	771	12 £5.00
	531	1 £10.00
	671	1 £75.00
	711	LOT £100.00
	747	4 £20.00
	932	1 £20.00
	886	3 £2.00
	640	1 £8.00
	802	1 £12.00
	917	1 £25.00
	575	1 £5.00
	696	2 £5.00
	378	15+ 4 £8.00
	903	1 £10.00
	775	1 £8.00
	941	2 £10.00
	402	12 £10.00
	859	1 TBC
	738	2 £8.00
	555	AS £4.00
	572	6 £5.00
	589	1 £20.00
	559	1 £20.00
	304	1 S + 2 L £20.00, £40.00
	382	4+2 £8.00



	TYPE	QUANTITY	PRICE EACH PER WEEK
CONCH SHELL – LORD OF THE FLIES	956	1	£15.00
CRUTCH – LONG JOHN SILVER STYLE (WOODEN) 1.2M, 1.3M, 1.4M LARGE	357	1	£5.00
CRUTCHES (PAIR) – OLD WW 1	509	1	£15.00
CRUTCHES – MODERN PAIR	584	2½	£12.00
CRYSTAL BALL EX NO 11 DOWNING STREET (DOES NOT WORK) 1L, 1 S	549	3	£ 25.00 £10.00
DESK SET BLOTTER ETC	864	1	£15.00
DESK SET, MODERN BRASS (70'S-80'S) THINK CONCORDE ERA	862	1	£15.00
DETONATOR FIRING BOX (FAKE) THINK.... WILE. E. CYOTE	850	1	£15.00
DRESSING TABLE SET	908	1	£8.00
EAR TRUMPET,I SAY.....EAR TRUMPET !	488	2	£5.00
ENCRIER (INK WELL) OLD FASHIONED (REPRODUCTION)	863	1	£15.00
ENIGMA MACHINE	574	1	£25.00
FAGIN'S BOX OF JEWELS	391	3	£10.00
FAN – PAPER EUORPEAN	964	6	£2.00
FAN – PAPER- JAPANESE	571	20	£2.00
FAN – PHARAOH'S	613	2	£12.00
FOOTBALL RATTLE , ARP 1941 USED AS AN AIR RAID SIREN FOR A VILLAGE	839	1	£10.00
FLY SWISH – PHARAOH'S.... OR ANYONE ELSE NEEDING A FLY SWISH!	885	1	£5.00
FLYING DUCKS SET OF 3 , PLASTER. VERY JACK AND VERA	921	1 SET	£18.00
FRENCH FLAG – LES MISERABLES, “BATTLE USED”	955	2	£10.00
GALVANISED METAL BUCKET AND SCRUBBING BRUSH – ANNIE ?	771	10	£5.00
GAVEL AND BLOCK	521	5	£8.00
GEIGER COUNTER- - “THE CHILDREN”	897	1	£50.00
GLADSTONE BAG	729	3	£10.00
GIANT HAIRSPRAY CAN – ADD STREAMER CANON £15 EA	615	1	£40.00
GONG - WHEN WE ARE MARRIED ETC	700	1	£20.00
GOOSE WITH THE GOLDEN EGG D	663	1	£18.00
GRANDFATHER CLOCK	876	1	£30.00
GREEN FLAGS - ANIMAL FARM	772	1 SET 2	£10.00
HANDKERCHIEFS, WASHING LINE & PEGS (LOT) APP 10 METRES	376	4	£15.00
HAT AND COAR STAND	962	1	£15.00
HOES AND RAKE, WOODEN AND PLASTIC FARM IMPLEMENTS	744	7+1	£4.00
HOUR GLASS – 1 SMALL 1 LARGE	546	2	£5 £10
IN AND OUT TRAYS (YES PRIME MINISTER)	844	1 PR	£.8.00
JUG AND BASIN	505	1	£12.00
JUKE BOX	879	1	£85.00
KALEIDOSCOPE	674	1	£10.00
KEYS LARGE BUNCH	232	5	£5.00
KNIFE GRINDER'S WHEEL	393	1	£30.00
LARYNGOSCOPE	496	1	£25.00
LEDGER	519	1	£10.00
LONGETTES (GLASSES ON STICK)	861	1	£20.00
MAGNIFYING GLASS – ART DECO	576	2	£10.00
MAGNIFYING GLASS – BRASS – BONE	550	1+1	£10.00 / £15.00
MANTLE CLOCK	503	9	£8.00
MARKET BARROW	372	2	£30.00
MEDICINE MAN'S STICK	486	2	£15.00
MEGAPHONE 1 ELECTIC, 1 BRASS	526	3	£10.00
MICROPHONE AND STAND 1930'S STYLE, FAKE	394	2	£15.00
MICROPHONE AND STAND 1930'S STYLE, WORKING	957	1	£20.00
MICROSCOPE, BRASS CIRCA 1900	746	1	£15.00
MILK CHURNS / PAILS	379	2 + 3	£10.00
MILKING STOOL	927	10	£10.00
MINISTERIAL RED BOXES – FAKE!	838	6	£25.00
MIRROR – BRASS SURROUND	504	1	£8.00
MIRROR - HAND HELD 1950'S 60'S	754	7	£5.00
MR BUMBLES STAFF	377	2	£10.00



TYPE 391



TYPE 897



	TYPE	QUANTITY	PRICE EACH PER WEEK
OIL DRUMS "WE WILL ROCK YOU"... OR ANYTHING ELSE REQUIRING...	708	3	£20.00
ORIENTAL PARASOLS / EUROPEAN PARASOL	688	4+10	£8.00
PARAFFIN HEATER 1930'S	675	1	£15.00
PARASOL (WHITE UMBRELLA)	825	9	£8.00
PIPES, OPIUM	757	2	£10.00
PIRATES OF PENZANCE KIT	62	2	£30.00
POCKET WATCH & CHAIN D 2 LARGE	585	20+ 2	S £5.00 L£10.00
POLICE WHISTLE – OLD STYLE	512	6	£1.00
PROJECTOR, EXPLODING -CALENDAR GIRLS FLASH £ 10.00 EACH	706	1	£50.00
QUILT (OKLAHOMA!)	902	1	£15.00
ROCKS - REALISTIC BUTPLASTIC 900 X 800 X700MM	774	2	£20.00
ROCKS – SMALL PLASTIC APP 150 X 110 X 90MM	959	20	£1.00
ROCKING CHAIR	901	1	£30.00
ROPE APP 32 MM DIA 10M LONG NAUTICAL SCENE	865	7	£10.00
ROSETTES	960	6 + 12	£1.00
ROW BOAT- FLINTSTONE PROPULSION – LOOKS GREAT	926	1	£30.00
RUSTIC WALKING STICKS	452	9	£3.00
SACKS. – FILLED WITH POLYSTYRENE CHIPPINGS	322	20	£2.00
SATCHEL, LEATHER AND POACHERS BAG	865	2 + 1	£15.00
SAUSAGES 2 – 'FALLEN MADONNA'	562	1	£10.00
SCHOOL DESKS- MIN ORDER 6	875	8	£25.00
SCROLLS	909	3	£10.00
SEXTANT – FULL SIZE	616	1	£15.00
SEXTANT – POCKET	532	1	£10.00
SHEPHERD'S CROOK	945	5	£5.00
SHIPS WHEEL	717	2	£25.00
SHOOTING STICK D	730	3	£9.00
SKELETON 1 PIRATE 1 PLAIN	629	2	£25.00
SIGNS SET OF 3 WIZARD OF OZ	905	1	£5.00
SILVER KETTLE AND COAL BURNER	704	1	£20.00
SIR HUMPHREY'S FOLDER (YES PRIME MINISTER)	843	1	£5.00
SNOW BALLS (FAKE)	776	LOT 10	£10.00
SPEAKING TUBE	513	2	£10.00
SPINNING WHEEL	928	1	£25.00
STETHOSCOPE	600	1	£6.00
STOKERS' SHOVELS – TITANIC	317	3	£12.00
TEA TROLLEY 1940'S – 1960'S	733	1	£20.00
TELESCOPE D	308	7	£10.00
TELESCOPE ON TRIPOD	884	1	£20.00
TELEVISION 1950'S 60'S WITH LED TO "WORK" MATILDA	942	1	£40.00
THRONE - UU	502	1	£20.00
THRONE – WOODEN M	916	1	£40.00
TONGS AND COAL	792	1	£5.00
TRIDENT, NEPTUNE. SEND FLASHES OF PYRO INTO AIR OVER 18 ONLY	734	1	£20.00
TYPE WRITER	664	2	£25.00
VANITY CASE	507	1	£5.00
WALLETS	375	45	£0.50
WHAT THE BUTLER SAW MACHINE	389	1	£30.00
WHEELCHAIR	598	1	£20.00
WIND MACHINE J	493	1	£50.00
WHISTLE – ACME THUNDERER	964	1	£4.00
WITCH'S BROOM STICKS IT DON'T FLY, SO DON'T TRY	601	3	£6.00
WITCH'S BROOM STICK WITH PYRO £ 10.00 EA- WIZARD OF OZ OVER 18'S ONLY	764	1	£25.00
WREATH, READS MUM / WOW - CALENDAR GIRLS	706	1	£10.00



TYPE 717
FISHERMAN'S FRIEND
NOT INCLUDED



TYPE 942



MONEY (TALK TO US FOR "WODGES" OF CASH) BUNDLES

	TYPE	QUANTITY	PRICE EACH PER WEEK
100 FRENCH FRANC NOTE		387	1 £4.00
1939 BANKNOTE 20 REICHMARK		573	1 £4.00
1970'S/80'S POUND NOTE		360	1 £4.00
1940'S POUND NOTE BLUE		399	1 £4.00
1960'S £10 NOTE		658	1 £4.00
1970'S £5 NOTE		361	1 £4.00
1980'S £10 NOTE		363	1 £4.00
1980'S £1 NOTE		374	1 £4.00
FRENCH FRANCS SMALL NOTES		400	AS POA
FOREIGN BANK NOTES <i>MANY</i> TYPES		633	AS FROM £4.00
OLD MONEY BOX AND COINS		791	1 £15.00
WHITE FIVER		364	AS POA
FAKE BRITISH NOTES (DADS ARMY SERIES) £5, £10, £20, £50.		856/8	AS POA



NEWSPAPERS

NEWSPAPER THE TIMES 1934, 1936. OLD STYLE		610	3 £5.00
NEWSPAPERS 1940S WW2 BRITISH		553	15 £5.00
NEWSPAPERS FRENCH PARIS MATCH 1940'S		561	15 £5.00
NEWSPAPER - VARIOUS HISTORIC HEADLINES		622	60+ £5.00
NEWSPAPER - GERMAN WW2		619	6 £5.00
PAPERS - SOUVENIR		617	12+ £5.00



RADIOS AND GRAMOPHONES ETC

1930'S CATHEDRAL RADIO		367	1 £15.00
1930'S MIC AND STAND FAKE		394	2 £12.00
1930'S MIC AND STAND - WORKING		957	1 £20.00
1950'2 MIC AND STAND		666	4 £20.00
1940'S WIND UP GRAMOPHONE		413	1 £30.00
1960'S TRANSISTOR RADIO		210	1 £12.00
1960'S TRANSISTOR RADIO		351	1 £12.00
ART DECO STYLE RADIO		337	1 £15.00
BAKELITE RADIO		370	1 £12.00
GRAMOPHONE D		58	1 £30.00
PHONOGRAPH D		514	2 £40.00
ROBERTS RADIO R24 1980'S		608	1 £10.00
SONY WALKMAN CASSETTE		667	1 £10.00
TAPE RECORDER (REEL TO REEL) 1980'S		643	2 £35.00



TELEPHONES

1920'S / 30'S ORNATE WHITE PHONE D R		323	1 £30.00
1920'S FRENCH MAGNETO PHONE		830	2 £30.00
1930'S TELEPHONE B+W - ORNATE R		64	1 £30.00
1930'S WHITE TELEPHONE ALSO RED R		416	1+1 £50.00
1930'S WOODEN TELEPHONE BELL		423	1 £10.00
1940'S / FAT SAMS PHONE R EXT BELL		77	1 £20.00
1940'S 10 EXT TELEPHONE D R EXT BELL		329	1 £20.00
1940'S PYRAMID PHONE R EXT BELL		273	3 £20.00
1940'S SEIMENS WIND UP MAGNETO TELEPHONE		829	1 £40.00
1940'S/ 50'S TELEPHONES D		309	2 £20.00
1980'S CORDLESS PHONE R		74	1 £20.00
1980'S OFFICE PHONE R		70	1 £20.00
1980'S WALL MOUNT PHONE R		405	1 £20.00
1990'S OFFICE PHONE R		71	1 £20.00
AMERICAN OFFICE PHONE		78	1 £25.00
AMERICAN 1978 DECO TEL TELPHONE D		896	1 £20.00
APOLLO 4000 ANSWERPHONE R		69	1 £20.00
BAKELITE / WOOD PHONE 1930'S? D		289	1 £20.00
BRASS TELEPHONE R		453	1 £20.00



TYPE 896



BRASS TELEPHONE
 CANDLESTICK PHONE R
 CANDLESTICK PHONE, WOODEN REPLICA
 ERICSON COBRA PHONE R
 FIELD TELEPHONE
 FIELD TELEPHONE / MORSE SENDER
 FIELD TELEPHONES - WW2 D
 FIXED LINE TELEPHONE
 FRENCH TELEPHONE 1950'S
 HMS WARSPITE PHONE
 MILITARY PHONE
 MOTOROLA 8500 MOBILE D
 MOTOROLA C520 MOBILE D
 MOTOROLA EXECUTIVE 2 D
 MOTOROLA GSM MOBILE D
 MOTOROLA MICRO TAC2 D
 MOTOROLA MPZ MOBILE D
 MOTOROLA STARTAC MOBILE D
 MOTOROLA TAC MOBILE D
 MOTOROLA TRANSPORTABLE 4500 D
 NAVAL TELEPHONE
 NOKIA 101 MOBILE D
 NOKIA 1XN MOBILE D
 NOKIA 5110
 NOKIA 5210
 NOKIA 6230
 NOKIA 9500
 O2 XDA
 ONYX TELEPHONE
 PAYPHONE (C 1971) R
 PINK PHONE D R
 PLAN 332 – REPRODUCTION - RED
 PLAN 400 1960'S - BLACK
 PLAN 400 PHONE 1960'S – GREEN R
 PLAN 400 RED PHONE D R
 PLAN 400 TELEPHONE R
 PLAN 400 TELEPHONE YELLOW R
 PLAN 400 TELEPHONE BEIGE R
 PLAN 400 WALL PHONE WHITE R
 PLAN 746 TELEPHONE GREEN D
 PLAN 7 76 SILVER JUBILLE COMPACT PHONE
 PTT 1950'S – 60'S BLACK TELEPHONE
 PUSH BUTTON PLAN 400 WHITE - YES PRIME MINISTER ?
 RED OR BLUE WALL MOUNT PHONE R
 RED TELEPHONE 1980'S
 SANYO G20
 SIEMENS C11 MOBILE D
 SEIMENS WIND UP PHONE 1930-40
 TELEPHONE RINGER
 TRIMPHONE DIAL D R
 TRIMPHONE PUSHBUTTON D R
 WALL MOUNT PHONE 1950'S D
 WALL MOUNT PHONE 1950'S D
 WALL MOUNT KELLOGG PHONE (WITH POST) BUGSY OR ANNIE ?...OR...
 WHITE TELEPHONE 1980'S
 VODAFONE EARLY "MOBILE" D



**CAMPER THAN A ROW OF TENTS
 LEGALLY BLONDE ?**



**"I AM NOT A NUMBER,
 I AM A FREE MAN"
 NAME THE SERIES....**



**TYPE 829
 AS SEEN IN THE FILM
 FORCE 10 FROM NAVARONE**



TYPE 416



TYPE 862

TYPE	QUANTITY	PRICE EACH PER WEEK	
	936	1	£30.00
	465	12	£20.00
	207	5	£18.00
	383	1	£20.00
	225	1	£20.00
	76	1	£20.00
	303	3	£20.00
	249	1	£20.00
	211	1	£20.00
	73	1	£30.00
	72	1	£25.00
	274	3+2	£20.00
	278	1	£15.00
	279	1	£15.00
	276	1	£15.00
	272	1	£15.00
	296	1	£15.00
	280	1	£15.00
	277	1	£15.00
	310	3	£20.00
	224	1	£20.00
	292	1	£15.00
	293	1	£15.00
	817	1	£15.00
	752	2	£15.00
	818	1	£15.00
	819	1	£15.00
	820	1	£15.00
	625	2	£20.00
	653	1	£20.00
	281	1	£20.00
	961	1	£20.00
	892	1	£20.00
	406	1	£20.00
	306	1	£20.00
	65	1	£20.00
	66	1	£20.00
	67	1	£20.00
	68	1	£20.00
	888	2	£20.00
	890	1	£20.00
	882	1	£20.00
	852	2	£20.00
	75	1+1	£10.00
	934	1	£20.00
	821	1	£15.00
	295	1	£15.00
	829	1	£40.00
	321	5	£18.00
	288	2	£20.00
	326	2	£20.00
	893	1	£20.00
	894	1	£20.00
	681	2	£20.00
	906	1	£20.00
	307	1	£20.00



WEAPONS *ALL FAKE! MOST OVER 18'S ONLY DUE TO VIOLENT CRIME REDUCTION ACT- LAW!*

"ACME" BOMBS AND DYNAMITE

AK 47 AUTOMATIC RIFLE

AMMO BOX OF 9 SHELLS (FAKE)

ARREST WARRANTS – THE CRUCIBLE - SALES

ARMY CARRY BAGS

AXE

BALL & CHAIN (PLASTIC)

BLANK FIRER / STARTING PISTOL BLANKS £ 2.00 EACH

BLUNDERBUS – FIRES PYRO. PYRO £ 10.00 EACH

CANON - SHIP A MUZZLE FLASH PYRO £ 15 EA OR STANDARD PYRO POA

COLT 45 (MODERN)

COLT 45 WITH HOLSTER (ANNIE GET YOUR GUN)

COLT PYTHON 123 REVOLVER 1955-2005

COLT 45 - SHORT BARRELLED

DERRINGER "STOCKING TOPPER"

EXECUTIONERS AXE AND BLOCK

FLAILS, SINGLE AND DOUBLE

FLINTLOCK PISTOLS

FLINTLOCK PISTOLS - PAIR

FLINTLOCK – DOUBLE BARRELED

GARROTTE

GAS MAKS 5 ADULT 2 CHILD D

GERMAN WW2 RIFLE 2 PLAIN , 4 WITH SIGHTS M

GUNSLINGERS DOUBLE HOLSTER AND PISTOLS

GUNSLINGER'S SINGLE HOLSTER AND PISTOL

HANDCUFFS 1940S KEY CLOSE, NOT SNAP SHUT. DON'T LOOSE THE KEY !

HANGMAN'S NOOSE

HATCHET AND THUMBSCREWS

HECKLER AND KOCH TYPE MACHINE GUN (FAKE) M

KNIVES -PLASTIC

LEE ENFIELD RIFLE M

LEWIS GUN (FAKE) - DAD'S ARMY

MACE

MAGNUM 357 (STLYE OF) THINK DIRTY HARRY

MANACLES 5 LONG +3 SHORT AND 4 LEG IRONS

MAUSER C96 SEMI AUTO MACHINE PISTOL

MINATURE SNUB NOSE REVOLVER... ER, CIGARETTE LIGHTER. 1970'S -STRANGE

MODERN HAND GUN, WALTHER P228

MP5 ASSAULT RIFLE - PLASTIC

MUSKET (FAKE) 4 M PLUS 3 OUR STOCK

MUSKET POWDER FLASK

ORNAMENTAL SWORD AND DAGGER, MOUNTED ON SHIELD

NAZI FLAGS (CONDITIONS APPLY)

PISTOL - PEPPERBOX TYPE

RUSSIAN WW2 HEAVY MCHINE GUN M

RUSSIAN MACHINE GUN WW2 M

SHOTGUNS AND RIFLE – FAKE M

SHOTGUN – REALISTIC BUT FAKE

SHOTGUN CARTRIDGE BELT

SHOTGUN- SAWN OFF (BANK ROBBERS ETC)

SMITH AND WESSON MODEL 10 - STYLE OF

SPEARS – WOODEN – LORD OF THE FLIES

SPLURGE GUNS, CANS OF SPLURGE £ 4.00 EACH KS

SPLURGE GUN BACKWARDS FIRING GUN. NEEDS 2 CANS PER FIRING! KS

STOCKS M

STRETCHER – WW1

SWORDS – FAKE, PLASTIC



TYPE 679



TYPE 722



	TYPE	QUANTITY	PRICE EACH PER WEEK
"ACME" BOMBS AND DYNAMITE		660	4 £10.00
AK 47 AUTOMATIC RIFLE		721	6 + 1 £30.00
AMMO BOX OF 9 SHELLS (FAKE)		302	1 £10.00
ARREST WARRANTS – THE CRUCIBLE - SALES		449	AS £5.00
ARMY CARRY BAGS		935	3 £10.00
AXE		473	1 £10.00
BALL & CHAIN (PLASTIC)		595	1 £8.00
BLANK FIRER / STARTING PISTOL BLANKS £ 2.00 EACH		842	1 £20.00
BLUNDERBUS – FIRES PYRO. PYRO £ 10.00 EACH		763	2 £30.00
CANON - SHIP A MUZZLE FLASH PYRO £ 15 EA OR STANDARD PYRO POA		679	2 £75.00
COLT 45 (MODERN)		785	1 £20.00
COLT 45 WITH HOLSTER (ANNIE GET YOUR GUN)		841	2 £35.00
COLT PYTHON 123 REVOLVER 1955-2005		883	1 £20.00
COLT 45 - SHORT BARRELLED		951	1 £20.00
DERRINGER "STOCKING TOPPER"		952	1 £20.00
EXECUTIONERS AXE AND BLOCK		672	1 £20.00
FLAILS, SINGLE AND DOUBLE		478	2 £10.00
FLINTLOCK PISTOLS		475	21 £15.00
FLINTLOCK PISTOLS - PAIR		627	1 £20.00
FLINTLOCK – DOUBLE BARRELED		967	1 £20.00
GARROTTE		472	1 £15.00
GAS MAKS 5 ADULT 2 CHILD D		933	7 £15.00
GERMAN WW2 RIFLE 2 PLAIN , 4 WITH SIGHTS M		741	2+4 £30.00
GUNSLINGERS DOUBLE HOLSTER AND PISTOLS		968	1 £45.00
GUNSLINGER'S SINGLE HOLSTER AND PISTOL		969	1 £35.00
HANDCUFFS 1940S KEY CLOSE, NOT SNAP SHUT. DON'T LOOSE THE KEY !		477	3 £15.00
HANGMAN'S NOOSE		481	1 £10.00
HATCHET AND THUMBSCREWS		471	1 £5.00
HECKLER AND KOCH TYPE MACHINE GUN (FAKE) M		723	2 £20.00
KNIVES -PLASTIC		736	6 £5.00
LEE ENFIELD RIFLE M		722	2 £30.00
LEWIS GUN (FAKE) - DAD'S ARMY		652	1 £15.00
MACE		470	2 £10.00
MAGNUM 357 (STLYE OF) THINK DIRTY HARRY		870	1 £ 20.00
MANACLES 5 LONG +3 SHORT AND 4 LEG IRONS		447	5+3+4 £5.00
MAUSER C96 SEMI AUTO MACHINE PISTOL		826	1 £20.00
MINATURE SNUB NOSE REVOLVER... ER, CIGARETTE LIGHTER. 1970'S -STRANGE		789	1 £10.00
MODERN HAND GUN, WALTHER P228		480	4 £20.00
MP5 ASSAULT RIFLE - PLASTIC		768	10 £15.00
MUSKET (FAKE) 4 M PLUS 3 OUR STOCK		720	4+4 £15.00
MUSKET POWDER FLASK		971	5 £ 10.00
ORNAMENTAL SWORD AND DAGGER, MOUNTED ON SHIELD		479	1 £20.00
NAZI FLAGS (CONDITIONS APPLY)		953	2 £10.00
PISTOL - PEPPERBOX TYPE		621	4 £10.00
RUSSIAN WW2 HEAVY MCHINE GUN M		739	1 £40.00
RUSSIAN MACHINE GUN WW2 M		740	6 £30.00
SHOTGUNS AND RIFLE – FAKE M		593	4 + 1 £15.00
SHOTGUN – REALISTIC BUT FAKE		799	1 £30.00
SHOTGUN CARTRIDGE BELT		923	3 £15.00
SHOTGUN- SAWN OFF (BANK ROBBERS ETC)		924	1 £25.00
SMITH AND WESSON MODEL 10 - STYLE OF		918	1 £20.00
SPEARS – WOODEN – LORD OF THE FLIES		954	6 £15.00
SPLURGE GUNS, CANS OF SPLURGE £ 4.00 EACH KS		670A	12+ £20.00
SPLURGE GUN BACKWARDS FIRING GUN. NEEDS 2 CANS PER FIRING! KS		670B	2 £40.00
STOCKS M		476	1 £ POA
STRETCHER – WW1		451	2 £20.00
SWORDS – FAKE, PLASTIC		836	2 £5.00



		TYPE	QUANTITY	PRICE EACH PER WEEK	
TAZER (FAKE)			618	1	£6.00
TIN HELMETS (PLASTIC)			189	12	£5.00
TOMMY GUN M			524	18	£30.00
TRUNCHEONS			397	12	£5.00
UZI SUB MACHINE PISTOL			769	10	£10.00
WALTHER P38 D			724	2	£20.00
WALTHER P38 PLASTIC REPLICAS			806	2	£10.00
WALTHER WITH SILENCERVERY JAMES BOND			837	2	£20.00
WEBLEY 38 MK4 D ALSO FAKE BULLETS £10.00 SET			725	2	£20.00
WHIP			448	2	£10.00
WINCHESTER RIFLE - ANNIE GET YOUR GUN ETC			840	1	£30.00

TYPE 724

TYPE 725

SOME PROPS ARE AGE APPROPRIATE OR HAVE OTHER CONDITIONS, TALK TO DAVID 01322 350 351

NEW PROPS

GIANT TURKEY			972	1	£25.00
KODAK EK2 CAMERA			973	1	£15.00
ENAMEL JUGS AND WATERING CANS (LITTLE SHOP OF HORRORS)			974	6+2	£10.00
GAS MASK (LITTLE SHOP OF HORRORS)			975	1	£15.00
GTE "KIRK" TELEPHONE 1987			976	1	£15.00
ALADDIN'S LAMPS (FLASH PAPER AND COTTON EXTRA)			977	2	£25.00
AGIFLEX CAMERA - 1950'S FLASHES - FLASH LAMPS £6.00 EACH			978	1	£15.00
SIEMENS ONE 2 ONE M200 MOBILE PHONE			979	1	£15.00
PAIR OF COFFIN TRESSLES			980	1	£10.00
BULLSEYE LANTERN			981	1	£20.00
PANASONIC HDD VIDEO CAMERA			982	1	£40.00
SONY HD VIDEO CAMERA			983	1	£40.00
CHAISE LONGUE			984	1	£40.00
CANDLE STICK SET OF 3, 3" DIA X 12-15" HIGH			985	3	£10.00
WREATH - BLUE AND WHITE			986	1	£10.00
CATAPULT			987	3	£10.00
PHOTGRAPHIC ENLARGER / ELECTRON MICROSCOPE			988	1	£20.00
BLUE TELEPHONE - FRENCH 1980'S			989	1	£20.00
FATME TELEPHONE -ITALIAN 1980'S			990	1	£20.00
SPITFIRE - MODEL - BLUE REMEMBERED HILLS			991	1	£3.00
CHILD'S PRAM - SILVER CROSS, ONLY THE BEST !			992	1	£20.00
RUSSIAN VT2 TELEPHONE BROWN - 1980'S			993	1	£20.00
RAY GUN (OLD ENGINE TIMING LIGHT)			994	1	£20.00
AMERICAN PAYPHONE			995	2	£ 40.00
OLD SACK BARROW			996	1	£20.00
GERMAN TELEPHONE FR REINER MUNCHEN MODEL W48 POST WAR		997	1	£20.00	
CHILD'S SPINNING TOP		998	1	£5.00	
BELL AND HOWELL 8MM CINE CAMERA		999	1	£15.00	
WEE-WILLIE-WINKIE - WOODEN FRENCH D <i>FIND ME ANOTHER !</i>		1000	1	£15.00	
WEE-WILLIE-WINKIE - WROUGHT IRON D		1001	1	£15.00	
GERMAN PEWTER JUG / URE		1002	1	£5.00	
CHERISH CR-709 TELEPHONE 1980'S ? D		1003	1	£20.00	
EDET CARRERA CLASSIC TELEPHONE MODERN D		1004	1	£20.00	
RHONDA BY PICCINI TELEPHONE-MODERN		1005	1	£20.00	
DIALATRON PHONANZA 10 - MODERN TELEPHONE D		1006	1	£20.00	
PRACTICE RIFLES - LEE ENFIELD STYLE D		1007	2	£20.00	
TELEPHONE BOOTH COVER D		1008	1	£40.00	
PAIR OF DOUBLE BARRELLED FLINTLOCK PISTOLS D		1009	1 PAIR	£30.00	
WOODEN CRATES M 8 WHITE 8 PLAIN		1010	8+8	£10.00	
1920'S WIND UP TELEPHONE		1011	1	£40.00	
1940'S CAFÉ WALL CLOCK FRENCH		1012	1	£10.00	
MAGIC BOOK, FOR MATILDA. LIGHTS UP WHEN OPENED		1013	1	£30.00	
DOG CART			1014	1	£30.00
1960'S ELECTRIC FIRE - FLYING SAUCER FIRE			1015	1	£40.00

TYPE 1015

TYPE 1013



MITSUBISHI MT9 MOBILE PHONE		
EASYLIFE MOBILE PHONE		
SHOP DOOR BELL - OLD FASHIONED		
SMALL BRASS WEE-WILLIE-WINKIE		
PAIR LONG BARRELLED COLT 45 (WESTERN)		
MAGNUM 44 – S1021 - STYLE OF		
SMALL HAND GUN		
COSINA CT7 CAMERA KIT		
BARONIAL FIREPLACE WITH LOG FIRE – AND DRESSING 1.5M WIDE 1.25M HIGH		
FROG – DAISY PULLS IT OFF		
HEADMASTER’S CANE – DON’T SEE IF IT WORKS ! DAISY PULLS IT OFF		
BLACKBOARD AND EASEL - DAISY PULLS IT OFF - MATILDA		
SCHOOL CREST PLAQUE – DAISY PULLS IT ORF		
TORCH LARGE AND HEAVY		
RUSSIAN TELEPHONE WHITE AND BLACK - 1980’S		
GERMAN 1980’S PHONE - BRIGHT ORANGE !		
ELECTRIC FIRE 1980’S COAL EFFECT		
PLAN 400 TELEPHONE – BROWN !		
THE AA M TRANSPORTABLE PHONE		
GERMAN WW2 RAILWAY TORCH		
HOCK GLASSES SET OF 4, 3 SETS GREEN , 1 SET BROWN		
HOCKEY STICKS -DAISY PULLS IT AUGH ! SPIFFING !		
1940’S BAKELITE RADIO		
LIMES		
GREEN CHILLIES		
HOSPITAL SCREENS 3 FOLD ON WHELPS - LITTLE SHOP OF HORRORS		
ELGIN SHERRY GLASSES – SET OF 6		
PUMPKINS		
RANSOM CASE WITH FUNNY MUNNY - MATILDA ETC		
GLOBES – 10”&12” DESK MOUNT		
BLUE PLAN 400 TELEPHONE		
THE MATILDA CHOCOLATE CAKE		
TINY TIMS CRUTCHES		
WALL LIGHT FLAME EFFECT		
SUNGLASSES SET OF 3 LEGALLY BLONDE-UPS GUY, THINK POLICE SQUAD....		
DOG BONE CAKE- LEGALLY BLONDE- VERY PINK !		
RIBBON MICROPHONE- LOOKS LIKE...1 BRONZED AND ONE..... SPARKLY PINK !		
PALM FRONS		
BENTWOOD CHAIRS MC DF		
LAVENDER PUSH BUTTON TELEPHONE		
SONY M5 VIDEO CAMERA		
CRUCIFIX – LARGE – SISTER ACT OR THE CRUCIBLE ETC-		
HAIR DRYER 1950’S / 60’S BAKELITE – GREASE ?		
RICARD GLASSES S (6) AND CARAFFE FOR WATER + TRAY – ‘ALLO, ‘ALLO		
FRENCH ENAMEL SIGN IV LICENCE - EVERY FRENCH CAFÉ HAS ONE !		
SET IF 6 WINE GLASSES - PLASTIC RE-USEABLE BUT JOHN LEWIS ! CLASSY		
SET OF 6 MARTINI GLASSES – PLASTIC DISPOSABLE		
SET OF 6 SHERRY SCHOONERS - GLASS		
SET OF 5 COCKTAIL GLASSES – PLASTIC DISPOSABLE		
PLAN 400 TELEPHONE WHITE, RED DIAL BEZZEL		
RED TELEPHONES SIMILAR TO FATME		
BLACK 1930’S -1950’S TELEPHONE		
MYSTERY TELEPHONE		
PAINTING OF THE FALLEN MADONNA WITH THE BIG BOOBIES BY VON KLUMPF		
COPPER BACK ELECTRIC FIRE (LED) 1920’S / 30’S		
AMANDA THRIPP DOLL 1M TALL – MATILDA - AWAITING SCHOOL UNIFORM		
P.I. SID THE NEWT – MATILDA COMES WITH JUG ETC		
SET OF 6 GIN /COCKTAIL GLASSES – PLASTIC RE-USEABLE		



**YES, SANTA WILL GET
DOWN THE CHIMNEY**

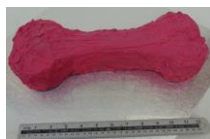

TYPE	QUANTITY	PRICE EACH PER WEEK
	1016	1 £15.00
	1017	1 £15.00
	1018	1 £10.00
	1019	1 £10.00
	1020	1 PAIR £20.00
	1021	1 £10.00
	1022	1 £10.00
	1023	1 £30.00
	1024	1 £65.00
	1025	1 £10.00
	1026	1 £10.00
	1027	1 £25.00
	1028	2 £20.00
	1029	1 £20.00
	1030	1 £20.00
	1031	1 £20.00
	1032	1 £20.00
	1033	1 £20.00
	1034	1 £20.00
	1035	1 £12.00
	1036	4 £10.00
	1037	11 £ 5.00
	1038	1 £15.00
	1039	36 £1.00
	1040	30 £1.00
	1041	1 £30.00
	1042	4 £10.00
	1043	6 £10.00
	1044	1 £25.00
	1045	1 £20.00
	1046	1 £20.00
	1047	1 £25.00
	1048	1 PAIR £15.00
	1049	2 £15.00
	1050	3 SETS £5.00
	1051	1 £15.00
	1052	2 £20.00
	1053	12 £8.00
	1054	6 + 6 £15.00
	1055	1 £20.00
	1056	1 £40.00
	1057	1 £20.00
	1058	1 £15.00
	1059	2 £15.00
	1060	1 £5.00
	1061	2 SETS £20.00
	1062	AS £10.00
	1063	3 SETS £10.00
	1064	AS £10.00
	1065	1 £20.00
	1067	2 £20.00
	1065	1 £20.00
	1069	1 £20.00
	1071	1 £20.00
	1072	1 £20.00
	1073	1 £30.00
	1074	1 £10.00
	1075	2 SETS £10.00



NOKIA CITYMAN MOBILE
 PHILLIPS FIZZ MOBILE
 SEIMENS MOBILE
 SAMSUNG MOBILE
 1990'S TELEPHONE
 WW2 MORSE SENDER AND HEADPHONES



1076	1	£10.00
1077	1	£10.00
1078	1	£10.00
1079	1	£10.00
1080	1	£20.00
1081	2	£20.00
1082	5	£8.00
1083	3	£3.00
1084	1	£10.00
1085	3+5	£3.00
1086	1	£10.00
1087	8	£3.00
1088	1	£20.00
1089	1 EACH	65.00

BABYCHAM GLASSES - **FRAGILE**
 LEATHER COVERED BOTTLES
 WHISKEY TUMBLERS SET OF 6
 BRASS CHALICE (PLUS 5 SILVER PLATED)
 HOCK GLASSES 200ML (BIG) SET OF 4
 OLD STYLE WINE BOTTLES - SORT OF 18TH CENTURY- BUT NOT ANTIQUES
 1990'2 TELEPHONE
 HATS AND WIGS- VARIOUS TOPPERS, BOWLERS ,TRILBYS GREEN AND PIGTAILS
 VIOLIN

GERMAN TELEPHONE – PRE COLD WAR ?
 BELL TELEPHONE – BELGIAN ?
 VINTAGE LAMPSHADES-INCL CABLE ETC
 FRENCH CHANDELIER – ‘ALLO, ‘ALLO ?
 ELECTRIC FIRE 1950'S-60'S
 SCANDINAVIAN TELEPHONE



1090	1	£15.00
1091	1	£20.00
1092	1	£20.00
1093	1	£10.00
1094	1	£30.00
1095	1	£20.00
1096	1	£20.00
1097	1	£15.00
1098	5	£15.00
1099	1	£15.00
1100	1	£15.00
1101	20	£10.00
1102	6	£5.00
1103	1	£15.00
1104	5	£10.00
1105	3	£10.00
1106	1	£20.00
1107	1	£20.00
1108	1 PR	£20.00
1109	2	£30.00
1110	10	£10.00
1111	1	£10.00
1112	6	£15.00
1113	3	£10.00
1114	1	£15.00
1115	1	£15.00
1116	5	£15.00
1117	3	£15.00
1118	1	£20.00
1119	1	£5.00
1120	1	£20.00
1121	2+2	£5.00
1122	2	£ 25.00
1123	AS	£ POA
1124	1	£30.00
1125	1+1	£25.00
1126	2	£5.00
1127	1	£25.00
1128	1 PAIR	£50.00
1029	1	£40.00
1130	2	£75.00
1131	1	£10.00
1132	1	£5.00
1133	AS	£10.00
1134	1	£25.00

KODAK NO 2 HAWKETTE 1920'S CAMERA - PRISTINE CONDITION - BAKELITE
 LIDDED WOODEN BEER CRATES
 TOUR DE FRANCE SIGN ENAMEL
 STOP AND GO SIGN
 SIMOCO 2 WAY RADIO OR A MOBILE PHONE OR MILITARY
 GOLD LOCKET

VICTORIAN TEA COSY AND SILVER TEA SET
 SILVER CANDLESTICKS
 SILVER TRAYS
 STRING OF SILK HANKIES
 TREASURE CHEST
 PAIR PEPPERBOX FLINTLOCK PISTOLS



STENOGRAPH
 LAPTOPS

MAP OF EUROPE
 CRATES PLAIN , SIT ON OR STAND ON
 ENAMEL AND OTHER SIGNS FRENCH- ‘ALLO, ‘ALLO

1000 FRENCH FRANC NOTE 1938
 100 FRENCH FRANC NOTE 1975
 BRASS AND COPPER BEER JUGS
 LARGE BRASS AND COPPER POT AND LADLE – OLIVER !
 SOLITAIRE 2000 PAYPHONE



WOODEN TRAY AZUR BISCUIT – ‘ALLO, ‘ALLO
 LOG BIN BRASS WITH LOGS – HEAVY !

RICARD / PERNOD ASHTRAYS
 BRASS CANELABRA 4 BRANCH
 999 FRENCH FRANKS.... M.LECLERC'S FORGERY
 LARGE BRASS CANDELABRA 5 BRANCH
 5 BRANCH CANDELABRA IN PEWTER OR SILVER



TYPE 1094

FLYING GOGGLES
 RADIO MIC AND CODE BOOK - ‘ALLO, ‘ALLO OF COURSE !

PAIR OF BOXED DUELING PISTOLS
 CHEESE SLLERS TRAY AND CHEESES - ‘ALLO, ‘ALLO - AGAIN

MOLE RICHARDSON 2KW FILM LIGHTS ON STANDS
 GARE NOUVION SIGN

OUVERT / FERME SIGN
 SET OF FRENCH FRANCS SMALL NOTES
 SET OF CAMEMBERTS (WITHOUT THE TRAY)



PICTURE FRAME FOR HERR FLICK
 CAMEMBERT PLATES ON STANDS + BREAD BOARD SET OF 4
 BUTLERS TRAY
 HELGAS NOTE BOOK PENCIL AND PENS SET
 CAFÉ RENE SIGN
 MANILA FOLDER FOR THE COLONEL INCL MAGAZINE
 SAFE
 TIGER SKIN RUG – **FAKE ! ITS POLYESTER**
 LEGAL DOCUMENTS
 HUNTERS BAG AND 2 BUNNIES
 WOODEN PITCHFORKS
 WINE GLASSES AND TRAY SET OF 6 + BOTTLE
 BRANDY GLASSES AND TRAY SMALL
 BRANDY GLASSES AND TRAY LARGE
 CHAMPAGNE COUPES 6 AND CHAMPAGNE AT COST
 LOOK ALIKE MOTOROLLA 8500 PHONES.... SOME **PINK !**
 WHISKEY DECANTER AND GLASSES ETC



1135	1	£20.00
1136	1	£10.00
1137	1	£10.00
1138	1	£10.00
1139	1	£10.00
1140	1	£ 5.00
1141	1	£40.00
1142	1	£30.00
1143	2	£ 5.00
1144	1	£15.00
1145	2	£10.00
1146	4	£10.00
1147	1	£10.00
1148	1	£10.00
1149	2	£10.00
1150	5+6+1	£10.00
1051	2	£20.00

HAD ONE OF THESE ?



THEN GET ONE OF THESE



THE DFS TEAM

AND GO FROM THIS.....



TO THAT



OR THIS.....



**CALL DAVID 01322 350 351
 INSTALLATIONS UPGRADES TO LED. HIRE AND SALES**



INSTALLATIONS AND SERVICE



INSTALLATIONS

**WE HAVE OVER 40 YEARS OF EXPERIENCE
OF INSTALLATIONS !**

LIGHTING

IN ADDITION TO OUR HIRE AND SALES SERVICE, WE ALSO INSTALL LIGHTING SYSTEMS AS PERMANENT RIGS. WE DESIGN AND BUILD SYSTEMS TO SUIT YOUR APPLICATIONS AND TRY TO GIVE YOU, THE CUSTOMER, THE MOST FLEXIBLE SYSTEM POSSIBLE. FOR EXAMPLE THIS COULD ALLOW YOU TO OPERATE PROSCENIUM ARCH, THEATRE IN THE ROUND OR THRUST STAGE. GENERALLY WE RECOMMEND THE SAME EQUIPMENT AS WE USE IN OUR HIRE STOCK BECAUSE WE ARE EXPERIENCED WITH THE SPECIFICATION AND KNOW THAT IT WILL BE ROBUST AND SUITABLE FOR ITS APPLICATION. IT ALSO REPRESENTS EXCELLENT VALUE FOR MONEY. MANY OF THE JOBS WE UNDERTAKE ARE UPGRADES AND IMPROVEMENTS TO EXISTING INSTALLATIONS AND WE ARE PLEASED TO DO THIS. WE WILL ADVISE YOU ON THE BEST WAY FORWARD. BECAUSE EACH VENUE IS DIFFERENT WE NEED TO DO A SITE VISIT TO ADVISE; SUCH VISITS ARE **FREE OF CHARGE**.

SOUND

WE ALSO SUPPLY PERMANENT SOUND INSTALLATIONS USING THE BEST EQUIPMENT. WITH SOUND, AS WITH MANY TECHNICAL ITEMS, IF PARTS OF THE EQUIPMENT ARE "CHEAP" WE THINK THE WORD "NASTY" FOLLOWS AND THE EFFECT IS ALL TOO OBVIOUS TO THE LISTENER. THIS IS WHY WE CHOOSE APPROPRIATE EQUIPMENT FROM MANY DIFFERENT MANUFACTURERS. BECAUSE WE HAVE THE EQUIPMENT IN OUR HIRE STOCK OR WILL HAVE, WE KNOW THAT, WITH THE CORRECT LEVEL SETTINGS, THE SOUND QUALITY WILL BE SUPERB AND WE CAN SUPPLY ACCOUSTIC PANELS TO TAME REVERB. WE WOULD NEED TO DO A SITE VISIT TO PROPERLY ASSESS YOUR REQUIREMENTS.

SERVICE, MAINTENANCE AND PORTABLE APPLIANCE TESTING, PUPER AND LOLER

WE CAN ALSO VISIT YOU TO SERVICE YOUR EQUIPMENT. THIS MAY BE NECESSARY TO ESTABLISH THE FAULT AND THEN DECIDE UPON THE BEST COURSE OF ACTION. SOME FAULTS CAN BE RECTIFIED ON SITE, SOME MAY NEED TO COME BACK TO OUR WORKSHOP AND SOME ARE A "RETURN TO THE MANUFACTURER" FAULT. IT IS DIFFICULT TO GIVE A SCALE OF CHARGES FOR SERVICE VISITS, AS THERE ARE SO MANY VARIABLES.

PLEASE LET US KNOW WITH PLENTY OF TIME UNTIL THE SHOW ! ...SOME PEOPLE.....BELIEVE IT OR NOT, LEAVE IT TO THE LAST MINUTE TO SAY THERE IS A PROBLEM,

THE IMPOSSIBLE WE CAN DO AT ONCEMIRACLES TAKE A LITTLE LONGER !

DID YOU KNOW THAT UNDER "THE ELECTRICITY AT WORK REGULATIONS 1989" ALL PORTABLE APPLIANCES MUST BE CLEANED AND ELECTRICALLY TESTED REGULARLY, PROBABLY EVERY YEAR. THIS IS ANY ITEM WITH A CABLE AND PLUG. OFTEN WE FIND THAT ALL OF A VENUE'S DOMESTIC APPLIANCES HAVE BEEN TESTED BUT THE STAGE LIGHTING EQUIPMENT HAS NOT. WE ALSO CLEAN THE LANTERNS TO GIVE YOU MORE LIGHT ! ASK YOURSELF, ***WAS IT DESIGNED WITH DUST INSIDE ?***

WHEN WE DO SUCH WORK WE ALSO INSPECT THE RIG FOR **PUPER** (PROVISION AND USE OF WORK EQUIPMENT REGS 1998) THIS IS ANYTHING WHICH MAY AFFECT SAFETY WHICH OFTEN CANNOT BE SEEN FROM THE GROUND BUT IS OBVIOUS WHEN UP IN THE GRID. THIS IS OFTEN INAPPROPRIATE ROPES HOLDING BARS UP OR INSUFFICIENT BULLDOG WIRE GRIPS ON SUSPENSION WIRES. WE WILL REPORT OUR FINDINGS TO YOU. WE WILL CORRECT THESE UPON YOUR INSTRUCTION.

AT A RECENT SITE VISIT WE FOUND THAT THE LED FIXTURES HAD BEEN LEFT ON 24/7/365 FOR 4 YEARS SINCE WE INSTALLED THEM. DUST AND DIRT CAUSED FAILURE OF THE FANS AND FIXTURE..... AND A BIG BILL, ALL FOR LACK OF SIMPLE MAINTENANCE. THE CONVENTIONAL LIGHTS HAD NOT BEEN CLEANED OR PAT TESTED FOR 27 YEARS !GRIMMMM CONDITION ! ***GLOVES AND MASKS REQUIRED....***

...NOTHING TO DO WITH COVID..... JUST THE DIRT !

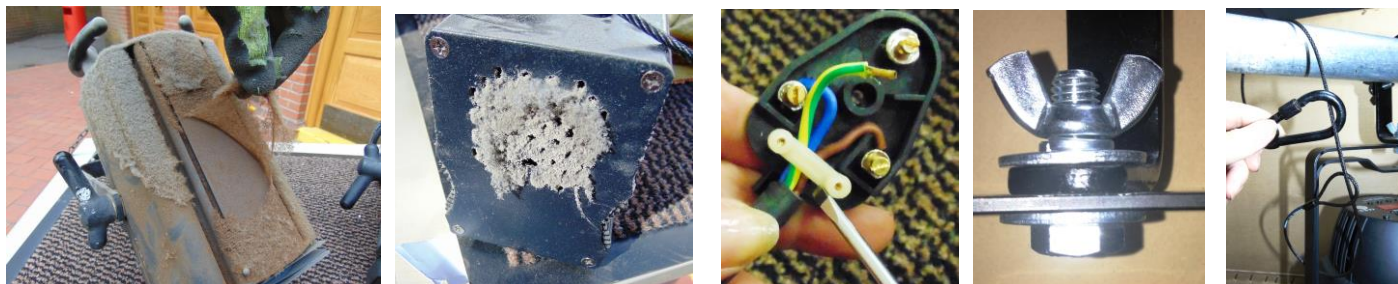

CENTRE, THE PLUG STILL WORKED WITHOUT THE EARTH AND THE CORD GRIP WAS LOOSE BUT WE CORRECTED IT TO MAKE IT SAFE. SHOWN RIGHT, THE CORRECT ARRANGEMENT OF BOLTS AND WASHERS AND USE OF SAFETY BONDS. WE OFTEN SEE PEOPLE GET THIS WRONG AND THE LANTERN WOBBLER OR THE SAFETY BOND FALLS OFF AND GETS LOST.



CURTAINS AND CURTAIN TRACKS

WE SUPPLY AND FIT CURTAINS AND CURTAIN TRACKS. THE CURTAINS WE SUPPLY ARE MADE FROM FLAME-PROOFED MATERIALS AND ARE OF THE HIGHEST QUALITY.

WE ALSO SERVICE TRACKS. WE FIND THAT ONE OF THE MAIN PROBLEMS IN SCHOOLS IS THAT THE WIRE ON TRACKS IS WOUND TOO FURIOUSLY AND IS OFTEN STRETCHED. SOMETIMES IT GETS KINKED AND AT THAT POINT, REPLACEMENT OF THE WIRE IS THE ONLY ANSWER. THESE JOBS ARE QUITE STRAIGHTFORWARD AND INEXPENSIVE. PLEASE CONTACT DAVID FOR YOUR **FREE SITE VISIT**.

SECOND HAND STOCK

WE OFTEN CARRY OUT A REFURBISHMENT OR UPGRADE AT A VENUE AND AS A RESULT WE OCCASIONALLY HAVE SOME SECOND HAND STOCK. THE EQUIPMENT IS SOLD IN A SAFE WORKING CONDITION BUT MAY SHOW SIGNS OF AGE ! LANTERNS SUCH AS THE PATT 123 AND PATT 743 ARE STILL OF SOME VALUETODAY. SOME OF THE OTHERS ARE NOT WORTH A LIGHT (THE PUN IS INTENDED) AND WE WOULD ADVISE YOU OF THE BEST WAY FORWARD.

OUR TEST IS "WOULD I BE HAPPY USING THIS LIGHT"YES OR NO ?

SORRY THE "B" WORD....OK WE'RE OUT, SO WE NOW HAVE TO "JUST DEAL WITH IT"

BREXIT AND WORLDWIDE. **WORLDWIDE** THE COST OF A CONTAINER SHIPMENT FROM CHINA WAS ABOUT £ 2000 AT THE START OF 2020.... IT IS NOW £ 20,000 NO ONE CAN ABSORB THAT SORT OF PRICE HIKE ! SIMPLE "O" LEVEL ECONOMICS, **COVID 19** HAS AFFECTED PRICES. GOODS FROM EUROPE, SOME OF WHICH COME FROM CHINA, **WE SIMPLY DON'T KNOW !** AND I DON'T THINK THE GOVERNMENT DO EITHER (OR THE OPPOSITION OR THE E.U.) ORIGINS AND ROUTES OF GOODS ARE SHOWN IN SALES SECTION FOLLOWING.....**UPDATE...**

AS I EXPECTED, GOODS COMING FROM THE E.U. HAVE GONE UP...IT'S NOT PROFITEERING ! THE JOURNEY FROM HUNGARY OR GERMANY WHERE MOST LAMPS ARE MADE, NOW TAKES ABOUT 10 DAYS INSTEAD OF 3.... BECAUSE OF CUSTOMS. **HOWEVER, RUSSIA'S WAR IN UKRAINE HAS MEANT THE GAS PRICE HAS INCREASED IN HUNGARY, SO TUNSGRAM HAVE STOPPED PRODUCTION OF ALL THEATRE LAMPS FOR THE TIME BEING, THEIR BANK IS NOT HELPING, WILL THEY SURVIVE ? NOT SURE AND WE CAN'T BLAME BREXIT.**

OUR JOB IS TO ADVISE WHICH EQUIPMENT IS THE CHEAP AND NASTY STUFF WHICH **WE** DON'T SELL AND WHAT IS "ACTUALLY RATHER GOOD" AND VALUE FOR YOUR MONEY !IT'S THE SAME EQUIPMENT THAT WE USE IN OUR HIRE STOCK !



NO MR BODGIT, I DON'T WANT TO "GET AWAY WITH IT" AT THE BUDGET END OF THE BODGE IT MARKET, NOR THE BODGE IT END OF THE BUDGET MARKET. I WILL GET ON TO DAVID FITCH FOR A PROPER JOB !

SWITCHING THE DESK OFF AT NIGHT BUT LEAVING THE POWER ON, COSTS YOU MONEY ! ON A 60 AMP SYSTEM, THIS COULD BE £ 5000 PER YEAR WASTED AS THE RACKS CAN RUN AT ABOUT 25% ON STANDBY.

THE SIMPLE SOLUTION, TURN THE RACKS OFF AT THE END OF THE DAY.

IT WOULD BE LIKE PUTTING THE CAR IN THE GARAGE AND LOCKING IT BUT KEEPING THE ENGINE RUNNING, YOU WOULDN'T DO IT AT HOME. JUST SWITCH IT OFF. A RETROFIT CONTACTOR SYSTEM IS AVAILABLE WHICH WILL ALLOW YOU TO DO THIS FROM A KEY SWITCH.

SWITCH IT OFF AT NIGHT AND HALVE THE ELECTRICITY COST !

SOME OF OUR RECENT INSTALLATIONS



LEFT, PADDINGTON ARTS CENTRE, BARROW HILLS SCHOOL AND FARRINGTONS SCHOOL BUILDING ON OUR RIG OF 24 YEARS EARLIER.



SALES

PRICES ARE CORRECT AT TIME OF GOING TO PRESS, "BREXIT" AND "COVID 19", SHIPPING COSTS ETC...CHECK WITH DAVID.

WHEN WE SELL LANTERNS, WE INCLUDE ALL OF THE BITS YOU WILL NEED. WE DON'T SUPPLY IT AS "A BAG OF BITS" AND TELL YOU TO GET ON WITH IT! WE PUT IT TOGETHER..... AND CONVENTIONAL LANTERNS ARE BURN IT IN!

TREFORE, THE LANTERN IS SUPPLIED TO YOU READY TO WORK !..... BUT DON'T LEAVE IT TOO LATE...SUPPLY CHAIN ISSUES !

TAPE PRICES REVISED SEPTEMBER 2023

BLACK GAFFA TAPE 50mm X 50M (ALSO SILVER OR WHITE)	NOT THE CHEAP AND NASTY!	£ 10.00
CAMERA BLACK GAFFA TAPE MATT 50mm X 50M	NOT THE CHEAP AND NASTY!	£ 15.00
DANCE FLOOR TAPE "CLEAR" 50mm X 33M		£ 12.00
PVC INSULATING TAPE (ALL COLOURS) 19mm X 33M		£ 1.25
FLUORESCENT GAFFA 25mm X 25M PINK OR GREEN		£ 12.00
HAZARD TAPE YELLOW / BLACK 50mm X 33M		£ 6.00
SCROLLER TAPE (25MM X 66M LIKE SELLOTAPE BUT HEAT RESISTING)		£ 15.00
GLOW IN THE DARK TAPE 20mm X 10M <i>NEW PRODUCT</i>		£ 15.00



COLOUR FRAMES SOME SECONDHAND ONLY AT MARKET PRICE

PATT 23	ONLY WHILST STOCKS LAST	£ 10.00
PATT 123		£ 10.00
PATT 743		£ 15.00
PATT 137 / S 64	SECONDHAND ONLY, AT MARKET PRICE	£ 15.00 APP
CODA		£ 20.00
SOURCE FOUR 19 ⁰ / 26 ⁰ / 36 ⁰ / JUNIOR ZOOM / SL		£ 12.00
SOURCE FOUR PAR / FULL ZOOM / PARNEL		£ 15.00
MINUETTE SIZE		£ 10.00
QUARTET SIZE		£ 12.00
PARCAN (BLACK OR SILVER)		£ 5.00



BARNDOORS

ACCLAIM SIZE		£ 56.00
--------------	--	---------



DFS FILTER CUTTING GUIDES AND CUTTING BOARDS

OUR CUTTING GUIDE IS A SIMPLE METAL PLATE USED TO CUT AROUND WITH A CRAFT KNIFE. THIS GIVES THE CORRECT SIZE OF FILTER AND KEEPS THE FINGERS AWAY FROM THE BLADE.

A3 SIZE CUTTING MAT (SELF HEALING)		£ 21.00
------------------------------------	--	---------

DFS CUTTING GUIDES

PATT 23	100mm x 100mm	£ 6.00
MINUETTE / ACCLAIM	125mm x 125mm	£ 6.50
PATT 123	155mm x 155mm	£ 7.00
PATT 743	210mm x 210mm	£ 8.00
QUARTET ETC	150mm x 150mm ALSO FITS	
SOURCE FOUR, SOURCE FOUR JUNIOR ZOOM / FORMA / SL AND TEMPO		£ 7.00
SOURCE FOUR 185mm x 185mm PAR / ZOOM / PARNEL / NOTA / ARIA		£ 8.00

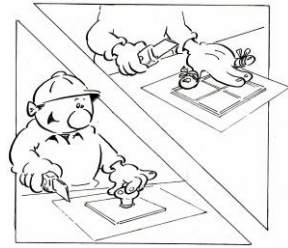

PAPER SNOW AND CONFETTI CANONS ETC

HAND HELD MULTICOLOURED STREAMER CANON 30" SINGLE USE	£ 15.00
HAND HELD WHITE / SILVER CONFETTI OR MULTICOLOURED CANNON 30" SINGLE USE	£ 15.00
HAND HELD RED HEARTS CONFETTI CANON 30" SINGLE USE	£ 15.00
500G BAG OF SNOW (APP 10 MINUTES IN OUR SNOW MACHINES)	£ 6.00

FILTER (PLEASE ASK FOR A FREE SWATCH BOOK)

LEE FILTER	48 X 21 INCH (STANDARD COLOURS)	£ 10.00
LEE FILTER ROLL	25' X 48 INCH (GIVES 14 SHEETS)	£ 124.36
ROSCO E-COLOUR	48 X 21 INCH	£ 10.00

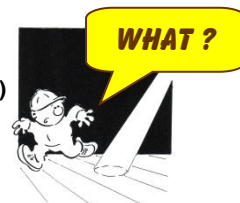

DFS FILTER STARTER PACKS

DEvised BY US, BEWARE OF PALE IMITATIONS !

A PACK OF 10 CAREFULLY SELECTED FILTERS IN HALF SHEET SIZES (24" X 21") FOR THE SMALL SCALE PRIMARY SCHOOL OR DRAMA STUDIO INSTALLATION.

POSTAGE £ 15.00 IF REQUIRED.

£ 49.00

GENERAL COLOURS

- 103 STRAW. WARM TONES. SUNLIGHT.
- 152 PALE GOLD. WARM TONES. GOOD FOR SKIN COLOUR. INTERIORS.
- 117 STEEL BLUE. COLD, SHARPENS FACIAL FEATURES, BALANCES STRAWS ETC

BOLD COLOURS

- 106 PRIMARY RED.
- 124 DARK GREEN.
- 767 OKLAHOMA YELLOW.
- 179 CHROME ORANGE.

SPECIAL COLOURS

- 161 SLATE BLUE. NIGHT SCENES.
- 008 DARK SALMON. VERY WARM TONES, GOOD FOR THE PANTO FAIRY !
- 170 DEEP LAVENDER. DRAMATIC COLOUR BUT DOESN'T DISTORT FACIAL COLOURING TOO MUCH.



THERE IS A SWATCH BOOK ENCLOSED OF ALL THE COLOURS AVAILABLE FROM LEE FILTERS. COLOUR IS A SUBJECTIVE AREA AND YOU MAY PREFER DIFFERENT COLOURS WHEN ORDERING FULL SIZED SHEETS IN FUTURE. PLEASE ASK FOR THE COLOUR BY NUMBER. THIS AVOIDS "CHINESE WHISPERS" SUCH AS "SKY BLUE PINK". THE FULL SHEET SIZE IS 48" X 21" PRICED AT £ 9.24 PER SHEET. **PRICES REVISED JANUARY 2024**

DFS DRAMA FILTER PACK 10

THIS IS 10 FULL SHEETS, ONE OF EACH OF THE FOLLOWING COLOURS:

103, 117, 152, 003, 170, 228, 104, 161, 124, 164. SEE SWATCH BOOK £ 92.40

DFS DRAMA FILTER PACK 20

THIS IS 20 FULL SHEETS, ONE OF EACH OF THE FOLLOWING COLOURS:

103, 117, 152, 003, 170, 228, 104, 161, 124, 164, 110, 201, 213, 136, 141, 119, 147, 179, 008, 128. SEE SWATCH BOOK £ 184.80

DFS DANCE FILTER PACK 20

THIS IS 20 FULL SHEETS, ONE OF EACH OF THE FOLLOWING COLOURS:

126, 795, 328, 111, 176, 106, 179, 010, 008, 213, 124, 139, 115, 183, 161, 195, 180, 058, 228, 152. SEE SWATCH BOOK £ 184.80

SPECIAL POST £ 15.00 ON STARTER PACKS & 10 PACKS NEXT DAY GUARANTEED. 1ST CLASS ON 20 PACK £ 20.00 PROBABLY NEXT DAY

GOBOS FOR PICTURES, PLEASE SEE OUR WEBSITE, BROCHURES, ROSCO. POSTAGE OF GOBOS IS EXTRA.

A GOBO IS A CUTOUT METAL PLATE GIVING AN IMAGE OF SAY A WINDOW OR TREE ETC. THEY ARE USED TO GIVE THE IMPRESSION OF SUCH AND THEY FIT IN A PROFILE SPOT. EACH SPOT WILL REQUIRE A PARTICULAR HOLDER, LET US KNOW WHICH LANTERN AND WE WILL ADVISE. IF YOU ARE NOT SURE OF THE MODEL, PLEASE EMAIL A PHOTO TO CONTACTUS@DAVIDFITCHSERVICES.COM

ROSCO STANDARD RANGE INCL DHA	A, B, C, D, E, M SIZE	£ 22.50
MESHED GOBOS	B SIZE	£ 22.50
GLASS GOBO, STANDARD		£ 45.00
COLOURWAVES		£ 103.50
PRISMATICS (GLASS GOBOS)		£ 97.00
GOBO HOLDERS - PLEASE SPECIFY LANTERN GH01-GH81 (EXCEPT BELOW)		£ 31.50
GOBO HOLDER GH50+GH80	£ 27.00 AND GOBO HOLDERS GH65-GH67	£ 34.00
APOLLO STANDARD GOBOS	B, M SIZE (MIN ORD 6, MIN 21 DAYS FROM USA!) PLUS POST	£ P.O.A
GOBOLAND GOBOS	(PLUS POSTAGE FROM BELGIUM)	£ P.O.A
CUSTOM GOBOS MADE TO ORDER PLEASE CALL DAVID - 01322 350 351		POA

DFS GOBO STARTER PACKS

DEvised BY US, BEWARE OF PALE IMITATIONS !

WE HAVE SELECTED A GOOD BASIC RANGE OF ROSCO GOBOS FOR TEACHING AND SHOW PURPOSES. THESE ARE SUGGESTIONS AND YOU MAY WANT TO CHANGE SOME OF THE SELECTION. PLEASE SEE OUR WEBSITE FOR THE ROSCO GOBO CATALOGUE AND OUR GOBO STARTER PACK DOCUMENT. GOBO HOLDERS ARE EXTRA

DFS GOBO STARTER PACK 6 A, B OR C

£ 135.00

DFS GOBO STARTER PACK 12 A OR B

£ 270.00

OR OF COURSE YOU MAY SELECT YOUR OWN !
GOBO HOLDERS ARE EXTRA.



LED PACKS

EACH COMES WITH A SHOWMASTER 48 DESK (96 SUBMASTERS BUT NO CUE STACK)
BUY FROM US AND WE PROVIDE ON SITE TRAINING**FREE!**
NO HEAT, LOW POWER CONSUMPTION, VERY BRIGHT COLOUR CHANGE, NO LAMPS OR
FILTERS! ALL COME WITH THE DESK, 2 STANDS AND ALL THE CABLES.

LED PACK 1

WITH 8 NO PERFORMER HEX LANTERNS (OR 6 HEX AND 2 ZOOM) **£ 3380.00**
THIS GIVES MAXIMUM COLOUR, R,G,B,W,A AND U.V. BUT NO BARNDOORS 6 AMPS.

LED PACK 2

WITH 6 NO MP 180 FRESNELS R, G, B, W, A, AND CYAN **£ 5410.00**
THIS GIVES A WIDE RANGE OF COLOUR AND ALLOWS FOR COLOUR TEMPERATURE ON
WHITE. (GOOD FOR TELEVISION) WOULD NEED TO CHANGE TO ZERO88 FLX S24 DESK
ADD £ 1686 FOR THIS FACILITY. ALSO BEAM CONTROL BY BARNDOORS. 8 AMPS.

LED PACK 3

WITH 8 NO MP 75 FRESNELS R,G,B,W **£ 3580.00**
THIS HAS A MORE BASIC RANGE OF COLOURS BUT BEAM CONTROL BY BARNOORS.
WE CAN EASILY ADD MORE MP 75 TO GIVE MORE AREAS BUT WOULD NEED TO SUPPLY
A LONGER T-BAR. AND DOUBLE UP THE FITTINGS ON START ADDRESS. OR WOULD
NEED TO CHANGE TO ZERO88 FLX S24 DESK ADD £ 1686 FOR THIS FACILITY. 2.5 AMPS.

DMX STAND PACKS WITH ZERO88 DIMMING AND LDR TEMPO FRESNELS

ALL COME WITH 2 STANDS, 2 ALPHA PACKS AND ALL THE CABLES. A SIMPLE 6 WAY
DESK

DMX STAND PACK A USING A BOTE 16 DMX DESK & ALPHA PACKS

WITH 6 NO TEMPO FRESNELS AND ALL THE CABLES. 16 AMPS. **£ 4600.00**

DMX STAND PACK B USING A BOTE 16 DMX DESK & ALPHA PACKS

WITH 8 NO TEMPO FRESNELS AND ALL THE CABLES. 21 AMPS. **£5196.00**

DMX STAND PACK C USING A BOTE 16 DMX DESK & ALPHA PACKS

WITH 12 NO TEMPO FRESNELS AND ALL THE CABLES. 32 AMPS. **£ 6384.00**

YOU NEED TO ALLOW FOR REPLACEMENT LAMPS AND FILTER IN THE FULLNESS OF TIME.

WIND UP STAND OPTION, REPLACE REF 49 STANDS WITH REF 55 ADD £1284.00 TO ANY SYSTEM
INCLUDES A 35 M + A 10M DMX CABLE AND 2 NO 13 AMP 10M MAINS CABLES WITH EACH SYSTEM.

AN ILLUSTRATION OF PACK B

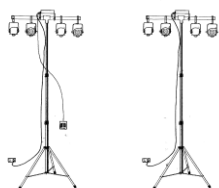

WITH THE STAND SET AGAINST A WALL
THE FURTHEST POINT OF THE LEG STANDS OFF
BY 1.4M THIS GIVES MAXIMUM STABILITY.

PLEASE NOTE

STAND PACKS DO NOT COME WITH FILTERS.
HOWEVER, WE SELL A FILTER STARTER PACK WITH
10 NO HALF SHEETS OF THE MOST USEFUL COLOURS
PRICED AT £ 49.00

ALSO WORTH CONSIDERING IS WHEN THE STAND IS
AT FULL HEIGHT, HAVE YOU GOT AN ADEQUATE STEP
LADDER? A 12 TREAD STEP LADDER (CLASS 1) IS
IDEAL, PRICED AT £ 250.00 PLEASE SEE PAGE 54 FOR
MORE DETAILS.



LAMPS

THESE ARE A FEW OF THE MOST COMMON

PRICE REVISED

SEPTEMBER 2024

MOSTLY . E.U. MADE

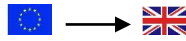

THIS MAY WELL CHANGE.....

LAMP	WATTS	LIFE	CAP	OUR PRICE	CORRECT AT TIME OF GOING TO PRESS
T17	500	750	P28	£ 25.00	
T18/T25	500	300	GY 9.5	£ 20.00	
T26/T27	650	400	GY 9.5	£ 20.00	
T11/T19	1000	750	GX 9.5	£ 20.00	
T29	1200	400	GX 9.5	£ 25.00	
HPL 575	575	400	PC G9.5	£ 20.00	
HPL 750	750	400	PC G9.5	£ 20.00	
GKV	600	300	G9.5	£ 25.00	
CP 60/61/62	1000	400	PAR 64 N / M / W	£ 30.00	
CP 88	500	400	PAR 64 N / M / W	£ 40.00	
M 40	500	2000	GY 9.5	£ 20.00	
M 38	300	2000	GY 9.5	£ 20.00	
T15	1000	750	P28	£ 50.00	
K1	400	2000	R7	£ 10.00	
K4	1000	2000	R7	£ 12.00	
P2/10	625	200	R7	£ 20.00	
P2/11	800	150	R7	£ 20.00	
P2/12	1250	200	R7	£ 20.00	
DXX	800	75	R7	£ 20.00	
PAR 30	75	300	E27	£ 10.00	
CP77	1000	300	G9.5	£ 25.00	
CP41 / CP73	2000	400	G38	£ 30.00	
CP43 / CP72	2000	400	GY16	£ 30.00	
CP53 / CP74	2000	400	P40	£ 50.00	

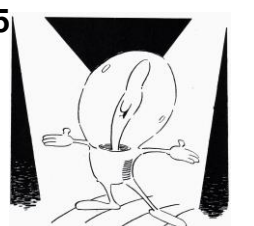

"FRED, THE LAMP'S SINGING AGAIN"

IN GREY, LAMPS THAT ARE GOING / GONE. NEW "OLD" STOCK ONLY, ...THAT IS... IF WE CAN GET THEM !

DON'T BELIEVE EVERYTHING (ANYTHING) YOU READ ON THE INTERNET !

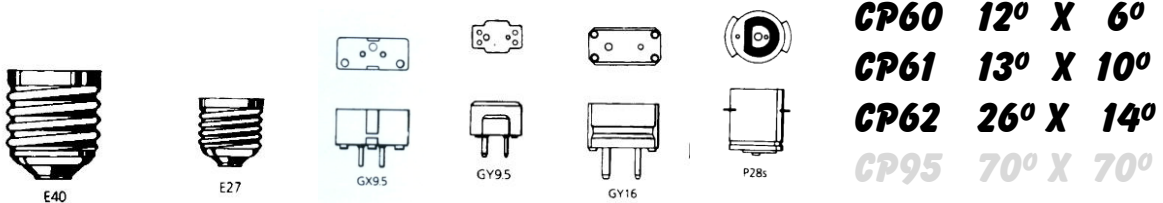

CP60 12° X 6°
CP61 13° X 10°
CP62 26° X 14°
CP95 70° X 70°

E = EDISON SCREW GX = EQUAL PINS GY = UNEQUAL PINS P = PRE-FOCUS BASE

LAMPS (NOT TO SCALE)

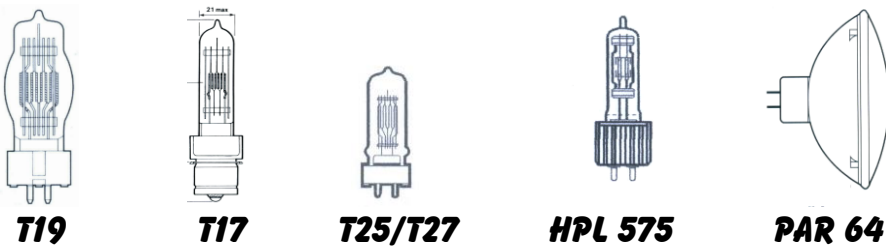

THE E.U. WAS PLANNING TO PHASE OUT TUNGSTEN LAMPS BY SEPTEMBER 2020.

HOWEVER, NOW THAT WE ARE OUT OF THE E.U.WE HAVE NO SAY IN FUTURE NEGOTIATIONS !

YET HERE'S THE RUB, BECAUSE RUSSIA HAS PUSHED THE PRICE OF GAS UP, TUNGSTEN CAN'T PRODUCE ANY LAMPS AS THEIR BANK & GOVERNMENT ARE NOT CO-OPERATING. WHERE HAVE WE HEARD THAT BEFORE ? OTHER PLAYERS ARE NOT SET UP TO MAKE ALL OF THE LAMP RANGE AND SOME LAMPS WILL DISAPPEAR. THIS WILL AFFECT ALL OF US.

IT IS LIKELY THAT MANY WILL GO AS NOT ENOUGH ARE MADE AND NO DOUBT THE PRICES WILL RISE

WATCH THIS SPACE ! DEVELOPMENTS ARE AFOOT ! (NOT 12") LAMPS ARE NOW BEING MADE IN MEXICO ! AND THEY ARE GOOD !

UPDATE SEPTEMBER 24YES THE LAMPS ARE HERE !



LE MAITRE PYROTECHNICS

(PRICES PER BOX OF 12, UNLESS OTHERWISE STATED)

OVER 18'S ONLY

FLASHES **BRITISH MADE**

PRICES REVISED 15TH SEPTEMBER 2023

THEATRICAL FLASH (SMALL1200A)
THEATRICAL FLASH (MEDIUM 1200)
THEATRICAL FLASH (LARGE 1200B)
RED FLASH (1200R) / GREEN FLASH (1200G) / ORANGE FLASH (1200Y)
THEATRICAL FLASH LOUD REPORT (1200C) / EXTRA LOUD (1200EL)

BOOK EARLY FOR CHRISTMAS !2024 !
REMEMBER LAST YEAR ? ...NO PYRO !

£ 75.00
£ 75.00
£ 76.00
£ 82.00
£ 76.00

STARS

SILVER STARS (SMALL1201A)
SILVER STARS (MEDIUM 1201)
SILVER STARS (LARGE 1201B)
GOLDEN STARS(MEDIUM 1202)
AMBER STARS (MEDIUM 1201Y)
RED STARS (MEDIUM 1201R) GREEN STARS (MEDIUM 1201G)



**I TOLD YOU TO TAKE
THE KEY OUT...**

£ 75.00
£ 76.00
£ 77.00
£129.00
£ 112.00
£ 112.00

COLOURED SMOKES (THE DYE MAY STAIN THE SET, COSTUMES AND ...ER,ACTORS)

MEDIUM SIZE RED (1209) BLUE (1210) GREEN (1211) YELLOW (1212)
WHITE (1213) ORANGE (1213B) VIOLET (1213C) ALL 6-8 SECONDS
LARGE SIZE RED (1214) BLUE (1215) GREEN (1216) YELLOW (1217)
WHITE (1218) ORANGE (1218B) VIOLET (1218C) ALL 25-30 SECONDS

£ 199.00
£ 229.00

THEATRICAL MAROONSTHESE MAKE A LOUD BANG ! ...THERE, TOLD YOU SO !

MICRODET (NON FRAGMENTAL HALF LOAD1227)
MICRODET (NON FRAGMENTAL1227A)
MICRODET (1227)

MAROONS DISCONTINUED BUT SEE PAGE 56

SILVER JET (1228)
REDUCED HEIGHT SILVER JET (1228H)
ROBOTICS (MEDIUM P504)
MINI GERBS SILVER (1231C)
SMALL FLAME PROJECTOR(EACH, 1718 ORANGE)



£ 97.00
£ 97.00
£ 122.00

£112.00
£ 112.00
£ 120.00
£ 152.00
£ 30.00

GLITTER CARTRIDGE (EACH, IT IS ACTUALLY METALIC CONFETTI)
(CHOICE OF RED 1230D, BLUE 1230C, GREEN 1230B, SILVER 1230A, GOLD 1230 OR
MULTI COLOURED 1230E)

£ 37.00

WHITE CONFETTI CARTRIDGE (EACH, PP501)

£ 30.00

MULTI COLOURED CONFETTI CARTRIDGE (EACH, PP502)

£ 30.00

CHINESE CONFETTI CARTRIDGE EACH (FLUTTERS FOR LONGER, CHOICE OF
RED PP499, BLUE PP496, GREEN PP497, WHITE PP500 OR MULTI COLOURED PP498)

£ 30.00

CONFETTI WHITE (LOOSE CONFETTI FOR CONFETTI CANON 1KG 7020P)

£ 31.00

GLITTER (AS ABOVE FOR CONFETTI CANON 1KG, METALIC CONFETTI 7021P)
(RED 1711, BLUE 1709, GREEN 1710, SILVER 1706, GOLD 1707 OR MULTI COLOURED 1712)

£ 37.00

CARDBOARD WAD FOR CONFETTI CANON (1700)

£ 6.00

FLASH PAPER (EACH FP01) (4 SHEETS PER PACKET)

£ 22.00

FLASH COTTON (EACH FP11)

£ 22.00

HARDWARE

2 WAY FIRER (ONLY)

N.B. ALL PYROTECHNICS CAN BE DANGEROUS.

£ 280.00

6 WAY FIRER (ONLY)

WE WILL ISSUE INSTRUCTIONS ON THE SAFE USE OF PYROTECHNICS.

£ 376.00

POWER SUPPLY

**WE RESERVE THE RIGHT TO REFUSE SERVICE AT OUR DISCRETION. WE MUST SELL ONLY IN
BOXED QUANTITIES. PYROTECHNICS CANNOT BE SENT BY POST. WE MUST USE A SPECIAL
CARRIER SERVICE WHICH CHARGES ITS OWN RATE. WE CAN DELIVER (CHARGEABLE SERVICE)
OR YOU MAY COLLECT. THAT IS THE LAW !**

£ 38.00

STANDARD POD

£ 110.00

ANGLE POD

£ 120.00

PYRO KEY

£ 5.00

ELECTRIC HAND HELD FLASH GUN (USES FLASH COTTON AND PAPER)

£ 84.00

DOUBLE ELECTRIC HAND HELD FLASH GUN (PLEASE SEE VIDEO CLIP ON OUR WEB SITE)

£ 115.00

GLOW PLUG FOR THE ABOVE

£ 20.00

APPROXIMATELY, EVERY 6 DECIBELS (DB) IS A DOUBLING OF THE NOISE !

FOR MAROONS PLEASE SEE PAGE 56, FOR MACAROONS SEE THE LOCAL PATISERIE.



UV PAINT IN AMERICAN PINTS, FLUORESCENT RANGE

UV PAINT 473mL (U.S. PINT)	COLOURS: BLUE, INVISIBLE BLUE,	£ 31.80
UV PAINT 946mL (U.S. QUART)	GOLD, ORANGE, GREEN, PINK, RED	£ 60.60
TEST KIT 9 X 28G POTS		£ 75.30

VIVID FX UV PAINT (DEEPER COLOUR SATURATION THAN THE FLUORESCENT RANGE)

UV VIVID PAINT 473mL (U.S. PINT, U.S. QUARTS AND GALLONS AVAILABLE)	£ 48.30
TEST KIT 9 X 28G POTS	£ 75.30

SUPERSATURATED PAINT (YOU MAY DILUTE WITH WATER UP TO 10:1)

BASIC COLOURS IRON RED, RAW UMBER, YELLOW OCHRE, BURNT UMBER, BURNT SIENNA, RAW UMBER, 1 LITRE	£ 32.10
---	---------

RED, TURQUOISE, PRUSSIAN BLUE, LEATHER LAKE, GRASS GREEN, CERULEAN BLUE, HUNTER GREEN, MOLY ORANGE,
VAN DYKE BROWN, ULTRAMARINE BLUE, CHROME GREEN, GREEN SHADE BLUE, PTHALO GREEN, MAGENTA, SPECTRUM RED,
CHROME YELLOW, ORANGE, RAW SIENNA, PURPLE, EMERALD GREEN, NAVY BLUE, NEW RED

1 LITRE	£ 42.00
NEW COLOURS	£ 45.60
TEST KIT 27 X 28G POTS	£ 75.30

OTHER PAINT PRODUCTS

TOUGH PRIME BLACK OR WHITE 1 U.S. GALLON 3.79L	£ 90.90
FOAMCOAT 1 U.S. GALLON 3.79L	£ 96.60
FLEXCOAT 1 U.S. GALLON 3.79L	£ 86.10
CRYSTAL GEL 1 U.S. GALLON 3.79L	£ 83.70

ROSCO SLIT DRAPE IS NOW DISCONTINUED.....

SCENIC PRODUCTS FROM OTHER SOURCES

BIO-DEGRADABLE GLITTER NOT PLASTIC !

SILVER, GOLD, RED, ROYAL BLUE, GREEN OR FUCHSIA	75G	£ 22.00
---	-----	---------

VAN DYKE CRYSTALS 500G MIX WITH WATER TO FORM A WOOD STAIN, USE GLOVES !	£ 25.00
--	---------

WELLS FIREWORKS

OVER 18'S ONLY BRITISH MADE 

SPECIALIST PYROTECHNIC PRODUCTS. PROFESSIONAL OR EXPERIENCED USE ONLY.

CANON MUZZLE BLAST TO GO WITH OUR TYPE 679 CANON	£ 32.00
FAWKENSIUM FUSE THE CLASSIC FUSE FOR "BOMBS" OR CANONS. 1 METRE LENGTH	£ 25.00
ELECTRIC IGNITOR	£ 10.00

WE RESERVE THE RIGHT TO REFUSE SERVICE AT OUR DISCRETION. THESE PRODUCTS CAN BE SENT BY SPECIAL CARRIER BUTSPECIAL RATES APPLY. CANNOT BE SENT BY POST ! WE CAN DELIVER OR YOU CAN COLLECT. THAT IS THE LAW !



**WHAT'S WRONG WITH YOUR "NEW" DESK ?
WELL, IT'S GOT A SLOT.....FOR COAL !
AND IT STILL HAS A FLOPPY DISC DRIVE.
WE ACTUALLY INSTALLED IT IN 1995.....
....YES, OVER A QUARTER OF A CENTURY AGO !
I THINK YOU HAVE HAD YOUR MONEY'S WORTH.**



FLX THE NEXT GENERATION OF LIGHTING DESKS, MORE POWERFUL THAN JESTER AND EVERYTHING BEFORE IT !**AND EXCELENT VALUE !**
BRITISH DESIGNED  **AND BUILT BUT WITH CHINESE COMPONENTS... THEN SHIPPED TO HOLLAND.... AND THEN BACK TO BRITAIN WITH TARRIFS... AND EXTRA SHIPPING COSTS. BONKERS IF YOU ASK ME...DIRECT CAUSE .BREXIT ! YES I AM SAYING TOLD YOU SO ! HOWEVER, THIS ISSUE HAS BEEN"SORTED"....(IT'S STILL THE BEST KIT THOUGH) "CHIPS IN EVERYTHING" THIS HAS BEEN THE PROBLEM. HOWEVER, GOOD NEWS ! THE PROBLEM IS NOW RESOLVED AND PRODUCTION IS BACK ON TRACK.....BUT STILL THE BREXIT PROBLEMS EXIST. (UPDATED PLASA 2024)**

FLX S24

24 SLIDERS 2 PAGES OF 24 SO 48 FIXTURES (WITH 2048 CHANNELS OF DMX) £ 2000.00

FLX S48

48 SLIDERS 2 PAGES OF 48 SO 96 FIXTURES (WITH 2048 CHANNELS OF DMX) £ 3000.00

RACKMOUNT EARS FOR EITHER DESK DISCONTINUED MARCH 24 £ 100.00

OUR RACKMOUNT EARS FOR EITHER DESK FREE IF YOU BUY THE CASE FROM US £ 40.00

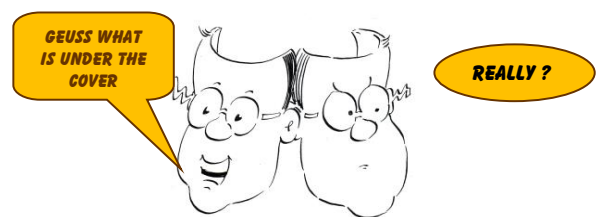

FLIGHT CASES AVAILABLE FOR FLX S24 AND S48 SEE PAGE 44. ALSO OUR GOOSENECK USB LIGHT £ 15.00
THE DFS SIMPLE DUST COVER IS FREE WHEN YOU BUY THE DESK FROM US...OR BUY ONE FOR £ 15.00

FLX DESK DISCONTINUED MARCH 24 !

IT HAS 4096 CHANNELS, 24-240 PLAYBACKS, A CUE STACK OF 10,000 CUES. A LIBRARY OF 10,000 FIXTURES, COLOUR CAPTURE (FROM A PHOTOGRAPH) COLOUR MATCHING FROM LEE, ROSCO AND OTHER RANGES OF FILTER. IT CAN HAVE A TOUCH SCREEN, AT COST AND IS INCREDIBLY POWERFUL.

8 UNIVERSES OF DMX 4096 CHANNELS ! £ 5026.00

HOWEVER, SO MUCH MORE DETAIL AVAILABLE ON OUR DATA SHEETS. PLEASE ASK FOR A COPY TO BE EMAILED TO YOU.



FLX S24



FLX S48

BETAPACK

WITH HARD POWER OPTION

BETAPACK 4 6 x 15AMP DOUBLE SOCKETS – DMX, MCB PROTECTION £ 1714.00^{EMU}
 x24 POSITIVE OR NEGATIVE OUTPUT IN SET OF 6 CHANNELS £495.00 SECOND HAND ONLY

ALPHA PACK

THREE CHANNEL MINI PACK WITH DMX INCL HOOK CLAMP AND BOND £ 970.00

CHILLI INSTALLATION DIMMER

CHILLI 12-10I BYPASS RCD 3 PHASE (DIMMER AND HOT POWER) MCB £ 3742.00

CHILLI PRO BYPASS 24-10I RCD 3 PHASE (DIMMER AND HOT POWER) £ 6046.00

CHILLI DIMMERS DISCONTINUED OCTOBER 2023 AS EVERYONE IS GOING LED !

NB JESTER AND SOLUTION ARE NOW GONE, SO SPARES ~~WILL BECOME DIFFICULT~~ HAVE BECOME IMPOSSIBLE ! ...THERE ARE NONE. IS THIS THE TIME TO UPGRADE TO FLX S4 OR 48 ?

TALK TO DAVID 01322 350 351

THERE'S NO POINT IN FLOGGING A DEAD HORSE !



ETC SOURCE FOUR

PRICES REVISED **SEPTEMBER 2023**

ALL LANTERNS ARE SUPPLIED READY TO WORK WITH HOOK CLAMP, SAFETY BOND, LAMP, PLUG AND COLOUR FRAME. ASSEMBLED AND BURNT IN.



AMERICAN MADE  → 

THE USA SPAT WITH MEXICO MAY BRING SOME PRICE RISES SOON AS MEXICO MAKES SOME COMPONENTS. NOW WITH PRESIDENT BIDEN MAYBE NOT, WHOKNOWS

PROFILES - 575 WATT

SOURCE FOUR JUNIOR ZOOM 25°/50° £ 596.00

PROFILES - 750 WATT

SOURCE FOUR 5° £ 1211.00

SOURCE FOUR 10° £ 1041.00

SOURCE FOUR 14° £ 1001.00

SOURCE FOUR 19°, 26°, 36° OR 50° £ 721.00

SOURCE FOUR ZOOM 25°/50° OR 15°/30° £ 1096.00

SOURCE FOUR 70° OR 90° £ 952.00

PAR - 750 WATT

SOURCE FOUR PAR - ALUMINIUM REFLECTOR - INCL LENS SET £ 356.00

SOURCE FOUR PAR SET OF FOUR LENSES £ 60.00

PARNEL - 750 WATT

SOURCE FOUR PARNEL 24°/47° BD EXTRA £ 606.00

BARNDOORS FOR PARNEL £ 60.00

ETC FRESNEL - 750 WATT

ETC FRESNEL 6°- 65° INCL BARNDOOR £ 691.00

AT LAST, A FRESNEL FROM ETC STUNNING OUTPUT....AND PRICE.... BEST THING SINCE SLICED BREAD ?

COLOUR FRAMES 150MM FOR JUNIORS OR SOURCE FOUR £ 12.00

COLOUR FRAMES 185 MM FOR SOURCE FOUR PAR OR FRESNEL £ 15.00

ETC ELEMENT 2 DESK PLEASE ASK FOR THE TECHNICAL SPEC TO BE SENT TO YOU

1024 CHANNELS OF DMX, 40 MULTI FUNCTION FADERS FOR SIMPLE CONTROL YET, HAS MANY MOVING LIGHT AND LED CAPABILITIES. £ 7250.00.



TOUCH SCREEN MONITORS (1) 19" (ALSO 17" OR 15" POA) £ 450.00

MONITORS (2) 19" VGA / DVI-D £ 140.00

OR 1 OFF EACH REQUIRED - *GUIDE PRICES ONLY.*

ETC COLOUR SOURCE DESK

COLOUR SOURCE 20 DESK £ 1685.00

COLOUR SOURCE 40 DESK £ 2645.00



FEATURE PACKED DESK FOR CONTROL OF CONVENTIONAL DIMMERS AND LED.

CUE STACK 999. COLOUR SOURCE 20 WILL CONTROL 40 CHANNELS WITH 10 PAGES OF 20 SUB MASTERS.

COLOUR SOURCE 40 WILL CONTROL 80 CHANNELS WITH 20 PAGES OF 20 SUBMASTERS. SOPHISTICATED

WITHOUT BEING TOO COMPLICATED, COMES WITH OUR 1 PAGE INSTRUCTION SHEET AND ON SITE

TRAINING INCLUDED.



LUCI DELLA RIBALA (LDR) IS AN ITALIAN MANUFACTURER. PLEASE SEE OUR WEBSITE FOR DATA SHEETS. ALL LANTERNS ARE SUPPLIED COMPLETE AND READY TO WORK INCLUDING "BURNING IN"

TEMPO 650 WATT FRESNEL 7° - 58° OR PC 8° - 60° (HAS A SIMPLE LAMP TRAY SLIDE)

INCL BARNDOORS, HOOK CLAMP, SAFETY BOND AND 15 AMP PLUG, READY TO WORK

FRESNEL VERSION

£ 295.00

PC VERSION

£ 310.00

THE TEMPO COLOUR FRAME IS THE SAME SIZE AS A SOURCE FOUR, SO, ONE SIZE OF COLOUR FITS BOTH! AND NOTA AND ARIA ARE THE SAME SIZE AS A SOURCE FOUR PAR, NEAT HUH? SEE PAGES 31 AND 32 FOR DETAILS OF OUR CUTTING GUIDES.



SUNO 650 WATT FRESNEL PC FRESNEL 7° - 58° PC 8° - 60° (HAS LEAD SCREW LAMP ADJUSTMENT)

INCL BARNDOORS, HOOK CLAMP, SAFETY BOND AND 15 AMP PLUG SUPPLIED READY TO WORK

£ 345.00

ARIA 6" FRESNEL 10° - 56° ARIA P.C. 8° - 60° (HAS A SIMPLE LAMP TRAY SLIDE)

INCL BARNDOORS, LAMP, HOOK CLAMP AND SAFETY BOND AND 15 AMP PLUG READY TO WORK EITHER 650w OR 1000w OR 1200w

£ 355.00

NOTA 6" FRESNEL 10° - 56° NOTA P.C. 8° - 60° (HAS LEAD SCREW LAMP ADJUSTMENT)

INCL BARNDOORS, LAMP, HOOK CLAMP AND SAFETY BOND AND 15 AMP PLUG READY TO WORK EITHER 650w OR 1000w OR 1200w

£ 385.00

CANTO FOLLOW SPOTS UNDER REVISION

THE CANTO RANGE OF FOLLOW SPOTS ARE EFFICIENT AND WE WERE VERY IMPRESSED WITH THE BUILD QUALITY AND THE COOL RUNNING, LOW WATTAGE FITTINGS. THIS IS JUST A SELECTION OF THE RANGE. ALL PRICES SHOWN ARE FOR THE FOLLOW SPOTS COMPLETE READY TO WORK WITH STAND, LAMP, BALL RACE SPIGOT, PLUG AND COLOUR MAGAZINE. THE CANTO 250 WATT MSD IS SMALL, EASY TO USE AND COOL RUNNING.

MODEL	WATTAGE	LAMP TYPE	BEAM ANGLE	THROW	PRICE
CANTO 250	250	MSD	10°/28°	2-15M	£ 2000.00
CANTO 575	575	MSD	8°/22°	10-30M	£ 2500.00
CANTO 700	700	MSD	8°/22°	10-35M	£ 2800.00
CANTO 1200	1200	MSR	8°/22°	10-40M	£ 3000.00
CANTO ASTRO	200	LED	8°/22°	10- 20M	£ 4150.00
ASTRO	100	LED	10°/20°	8-15M	£ 2940.00

LDR COLOUR FRAMES AND BARNDOORS TO FIT OTHER LANTERNS

LDR AND EQUIVELENT LANTERNS

			COLOUR FRAME	BARN DOOR
SOFFIO	125MM	MINIM, MINUETTE ACCLAIM	£ 10.00	£ 56.00
TEMPO	150MM	QUARTET, PRELUDE, SOURCE FOUR AND JUNIOR ZOOM	£ 12.00	£ 56.00
ARIA	185MM	SOURCE 4 PAR, SOURCE 4 FRESNEL, RAMA, FREEDOM.	£ 15.00	£ 60.00
TONO	245MM	ADB 2KW	£ 20.00	£ 72.00

SIRIUS SPARES

SIRIUS KEY

£ 10.00

SIRIUS / XL / XLS BATTERY TO BE SOLDERED TO PCB FITTING EXTRA.

SIRIUS 48 REQUIRES 2 £ 10.00

£ 100.00



WE CAN SERVICE YOUR STAGE LIGHTING ETC CALL DAVID

N.B. OLDER DESKS SUCH AS SIRIUS, FROG, ORB, SOLUTION AND NOW JESTER, THERE ARE SIMPLY **NO SPARES AVAILABLE**, SO UNFORTUNATLY, NO REPAIRS ! EQUIPMENT MOVES ON AND THE **FLX S24** IS VERY GOOD VALUE FOR MONEY AND IT DOES FAR MORE.

"THERES NO POINT IN FLOGGING A DEAD HORSE"





**ACCLAIM, RAMA AND ALL THE CONVENTIONAL LANTERNS – ARE GONE !
AND SO ARE ALL THE SPARES**



ACCLAIM LED PROFILE SPOT RGB AND LIME
ALL THE USUAL LENS SIZES AVAILAVLE

£ 2928.00

ACCLAIM LED FRESNEL RGBL FRESNEL 150 WATT

£ 1202.00

ALL PRODUCTS IN DEVELOPMENT

MIRROR BALLS ETC**SEPTEMBER 2023**

CHINESE IMPORT FROM E.U.



N.B. WE DO NOT KEEP THESE IN STOCK AND THE LEAD TIME IS APPROXIMATELY 10 DAYS TO GET THE BALLS FROM EUROPE.

8mm GLASS FACETS ON A HARD POLYTHENE BASE, LARGER MIRROR BALLS, 30" (750mm) AND ABOVE ARE ON CARBON FIBRE SUBSTRATE. CARRIAGE FROM EUROPE IS INCLUDED ON 750mm AND ABOVE.

1.5 M MIRROR BALL 60420	60"	142 KG
1 M MIRROR BALL 60410	39"	37 KG
750mm MIRROR BALL 60409	30"	22 KG
500mm MIRROR BALL 60407	20"	
400mm MIRROR BALL 60406	16"	
300mm MIRROR BALL 60405	12"	

**DOH!**

£ 4300.00
£ 1250.00
£ 715.00
£ 150.00
£ 90.00
£ 60.00

750mm GOLD MIRROR BALL 30"	£ 552.00
600mm GOLD MIRROR BALL 24"	£ 250.00
500mm GOLD MIRROR BALL 20"	£ 185.00
400mm GOLD MIRROR BALL 16"	£ 90.00
300mm GOLD MIRROR BALL 12"	£ 50.00

HD ROTATOR 2 RPM UP TO 100KG / 1M (INCL HOOK CLAMPS AND SAFETY STROP)	£ 250.00
HD ROTATOR DMX .5 REVS PER HOUR - 2RPM UP TO 1M / 65 KG (AS ABOVE)	£ 350.00
SUPER HD ROTATOR 2 RPM UP TO 150 KG ON HALF COULPERS	£ 520.00
THE MEGA ROTATOR .5 RPM - 5 RPM DMX 500KG THIS IS NOT A MISPRINT !	£ 3300.00
100 KG KARABINER GOLD....COLOUR, NOT REAL GOLD.....MUPPET !	£ 15.00
100 KG STROPS WITH KARABINER AT EACH END	
.5 M	£ 40.00
1 M	£ 48.00
1.5 M	£ 55.00
2 M	£ 60.00

PLEASE NOTE, WE DO NOT SELL CHEAP ROTATORS. THEY ARE NOT SAFE ! IF WE DO NOT USE THEM, WHY SHOULD YOU ?

THE SURFACE AREA OF A SPHERE IS $4\pi r^2$ SO AN EXPONENTIAL EXPANSION ! THAT IS WHY THE PRICE INCREASES SUCH WITH SIZE ! MIRROR BALLS COME IN METRIC SIZES, NOT IMPERIAL ! ALL OF THESE ARE HAND MADE. SPECIAL ORDER IN CHINA THE LEAD TIME IS FROM 12 WEEKS....UPWARDS ! AND WE CAN'T MAKE THEM GO ANY FASTER. SOME SAY "I WANT A 2M MIRROR BALL" YES YOU CAN PLEASE FIND £ 8500.... WITH 127,000 MIRROR STUCK ON BY HAND, NEEDS A MEGA ROTATOR, PLUS A FLIGHTCASE THEN SHIPPED HALF WAY AROUND THE WORLD !

PLEASE, DON'T ASK FOR IT FOR NEXT WEEK !

PROEL MUSIC STANDSPRICES REVISED **SEPTEMBER 2022**

SOLID TRAY, TRIPOD BASE MUSIC STAND	RSM360	£ 30.00
CLIP ON LIGHT TO SUIT ABOVE STAND	RSM430	£ 29.90
DOUBLE LAMP VERSION FOR CONDUCTORS STAND	RSM 430D	£ 53.40



£ 30.00
£ 29.90
£ 53.40



MODEL	WATTS	OUTPUT	DMX	HANGING?	USES/ COMMENTS	PRICE
		CU FT/MIN				
SIMPLE SMOKE						
F 80Z	700	2500	NO	NO	DJ / SMALL STAGE	£ 158.00
Z800II	700	3000	NO	YES	QUIET BUT SLOW	£ 235.00
Z1200II	1200	18,000	YES	YES	MEDIUM STAGE	£535.00
Z1500II	1500	20,000	YES	NO	MEDIUM STAGE (SEC. SCHOOL)	£ 707.00
Z 3000	3000	40,000	YES	NO	LARGE STAGE	£872.00
Z1520	1000	10,000	YES	YES	VERTICAL JET APP 3M	£790.00
HAZE MACHINES						
F1	700	3500	YES	NO	LARGER STAGE£	£ 898.00
FAZER						
HZ350	75	1000	NO	NO	PREMIUM HAZE	£ 940.00
HZ500		2800	YES	NO	CRACKED OIL MACHINE FLIGHTCASED	£ 1884.00
HEAVY FOG MACHINES						
OVER ICE	1000	8000	YES	NO	REQUIRES ICE	£970.00
DNG 100 (FC 100)	750	DEPENDS	NO	NO WAY !	USES Z1500 OR SIMILAR ADD HOSE APP £150.00	£ 4050.00

SMOKE FLUIDS

LE MAITRE MINI MIST CANISTER	£ 10.00
MAGICAN ... HAZE IN A CAN 60659 GOOD FOR SMALL AMOUNTS FOR PHOTOGRAPHY	£ 18.00
DNG LOW FOG FLUID FLU 09 5 LITRE	£ 20.00
HAZE FLUID FLU 06 5 LITRE	£ 17.00
SMOKE FLUID FLU 12 5 LITRE	£ 17.00
ANTARI CRACKED OIL FOR HZ500 5 LITRE	£ 76.00

WE CANNOT SEND PAINTS OR FLUIDS BY POST BECAUSE IF THEY LEAK, THE RESULTANT INVESTIGATION IS VERY DIFFICULT AND IN THE END EVERYONE IS UNHAPPY. BY THE WAY, ANY COLOUR OF THE FLUID IS ONLY FOR IDENTIFYING STOCK, THE SMOKE ALWAYS COMES OUT WHITE !

IT PAYS TO FLUSH YOUR SMOKE MACHINE WITH DISTILLED WATER EVERY 6 MONTHS OR SO, PLEASE ASK US FOR DETAILS.

DNG200 HEAVY FOG MACHINE
40,000 CUBIC FEET PER MINUTE
TWICE THE OUTPUT OF THE DNG 100

£ 9229.00
A SERIOUS MACHINE !

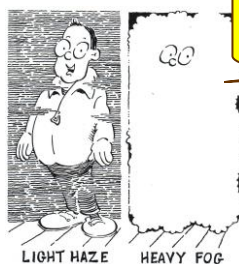

WILL YOU STOP PRESSING THE BUTTON !



RACK CABINETS

DIRECT IMPORT FROM CHINA



SEPTEMBER 2023

TROLLEY 8U HIGH WITH 8U FOR MIXER	D7367B ON CASTORS	£ 500.00
TROLLEY 12U HIGH WITH 10U FOR MIXER & LAPTOP SHELF	FC172 ON CASTORS	£ 540.00
TROLLEY 18U HIGH WITH 10U AS ABOVE WITH TABLE FOR OTHER KIT	FC172 B ON CASTORS	£ 560.00
TABLE TOP CASE 4U WITH 10U FOR MIXER	D73788	£ 300.00
TABLE TOP CASE 6U WITH 10U FOR MIXER	D73698	£ 328.00
RACK CABINET 16U	PENN 055 STEEL, THESE ARRIVES FLAT PACKED	£ 172.00
RACK CABINET 20U	PENN 056	£ 176.00
RACK CABINET 35U	PENN 059	£ 270.00
RACK DRAWER 2U	PENN 041	£ 70.00
RACK DRAWER 3U	PENN 042	£ 80.00
RACK DRAWER 4U	PENN 043	£ 140.00
RACK BLANK PLATE 1U	PENN 018	£ 12.00
RACK BLANK PLATE 2U	PENN 020	£ 15.00
RACK BLANK PLATE 3U	PENN 021	£ 18.00
RACK BLANK PLATE 4U	PENN 022	£ 20.00
VENTED BLANK PLATE 1U	PENN 03	£ 15.00
VENTED BLANK PLATE 2U	PENN 03	£ 18.00
UNIVERSAL RACK TRAY	PENN 014	£ 25.00



D7367 B



FC 172



FC 172 B



D 7378 B

FLIGHT CASES

CARRIAGE IS EXTRA **CHINESE IMPORT.**



OPENING LID WITH HINGES ON LONG SIDE, TRUNK STYLE.	N.B. <u>INTERNAL SIZES</u>
FC74S CASE	540L X 345W X 370H £ 252.00
FC75S CASE	740L X 540W X 370H £ 368.00
FC82S CASE	740L X 345W X 370H £ 276.00
FC83S CASE	1140L X 340W X 425H £ 350.00
FC66 TOURING CASE	1175L X 540W X 580H + CASTORS £ 800.00
DIVIDERS FOR FC66	£ 20.00

FLIGHT CASES FOR ZERO88 FLX S24 AND S48 DESKS

FC 76 CASE FOR FLX S24 INCL RACKMOUNT	550 X 410 X 185	£ 200.00
FC 49 CASE FOR FLX S48 INCL RACKMOUNT	780 X 410 X 185	£ 220.00



RADIO MIC AND EQUIPMENT RACK CASE

CASE 150 4U		£ 180.00
CASE 151 6U		£ 200.00
CASE 152 8U		£ 240.00

EQUIPMENT NOT INCLUDED BUT THEN THE EMPTY FLIGHTCASE, IS NOT VERY INTERESTING AS A PHOTO.

SUBMASTER 48 WAY DMX LIGHTING DESK

LEFT, A 48 WAY DMX SUBMASTER DESK WITH 36 SUBMASTERS AND 48 CHASES (MULTI PURPOSE FOR THEATRE AND DISCO) RIGHT, THE 48 WAY SUBMASTER DESK WITH 96 SUBMASTERS AND / OR CHASES, NO CUE STACK BUT ...BEST FOR THEATRE.



£ 350.00

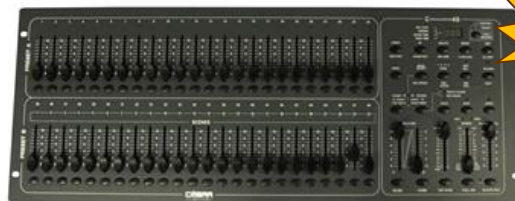

£ 400.00



THE DFS "BIG MARKING UP KIT"

1 ROLL WHITE PVC TAPE, A CD MARKER PEN, 1 NO ROLL OF GLOW IN THE DARK TAPE, 5 ROLLS OF PVC TAPES OF VARIOUS COLOURS, A SCRIPT MARKING PEN, A 4B PENCIL FOR MARKING HIRED IN SCRIPTS, A CHINAGRAPH PENCIL, A SCALE RULE, A3 SIZE GRAPH PAPER, A 1:25 AND 1:50 SCALE LANTERN STENCIL. 1 ROLL BLACK GAFFA TAPE, 1 ROLL HAZARD TAPE, 1 PACKET RESEALABLE CABLE TIES AND A ROLL OF SCROLLER TAPE, BUT NO CUDDLY TOY !

ALL FOR JUST £ 85.00

THE DFS "LITTLE MARKING UP KIT"

2 ROLLS WHITE PVC TAPE , 1 ROLL GLOW IN THE DARK TAPE. 1 CD MARKER PEN TO WRITE ON THE WHITE PVC TAPE AND 1 SCRIPT PEN

£ 20.00

NOT A MICKEY MOUSE KIT BUT REALLY USEFUL BITS ! WHY THE WHITE PVC TAPE ? IT DOES NOT LEAVE A STICKY MESS AS MASKING TAPE DOES ON YOUR LIGHTING AND SOUND DESKS. THEN YOU MARK WITH THE CD PEN WHAT EACH CHANNEL DOES. THE GLOW IN THE DARK TAPE CAN BE USED FOR ACTORS MARKS OR TO SHOW THE EDGE OF THE STAGETO HELP STOP PEOPLE FALLING OFF IN THE BLACKOUTUSEFUL ?.... THE SCRIPT PEN ? NICE BOLD LINE AS BIRO OR PENCIL ARE A COMPLETE PAIN.....IN THE DARK !

TECPRO TALKBACK SYSTEMS

SEPTEMBER 2023

A FIXED LINE TALK BACK SYSTEM FOR COMMUNICATION BETWEEN THE STAGE MANAGER, LIGHTING, SOUND AND FOLLOW SPOT OPERATORS AS WELL AS ANY OTHER TECHNICAL STAFF ON A PRODUCTION. THIS USES A BELT PACK WITH A SINGLE MUFF HEADSET. THE SYSTEM NORMALLY OPERATES ON AN OPEN CIRCUIT, SO THAT EVERYONE COULD TALK AT ONCE I.E. WITHOUT OPENING THE MICROPHONE TO SPEAK. YOU MAY ALSO OPERATE ON "PUSH TO TALK" OR IF THE PLAY IS VERY QUIET, THERE IS A CALL BUTTON FROM WHICH YOU HEAR A "CLICK" IN ORDER TO PICK UP YOUR CUE. ALL OF THESE ARE CONNECTED BY STANDARD 3PIN XLR CABLES AND ARE DAISY CHAINED TOGETHER.

FIXED LINE

POWER SUPPLY UNIT PS751

SINGLE MUFF HEADSET HSG1

BELT PACK BP511

LOUDSPEAKER OUTSTATION LS372

FOR DRESSING ROOMS ETC MIC £120 EXTRA

MANY OTHER ITEMS AVAILABLE

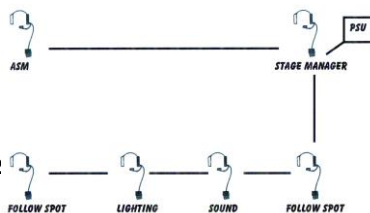

£ 500.00

£ 200.00

£ 300.00

£ 700.00

POWERDRIVE STANDS

PRICES REVISED SEPTEMBER 2023 **BRITISH MADE**

STANDS

REF 55 WIND UP STAND 4.6M SO EASY !

REF 49 4.5M (15') 3 SECTION

REF 44 2.4M (8') 2 SECTION

T BARS (NEEDS A STAND TOP REF 14/2 OR 14/3)

REF 25 0.6M T BAR 2 LANTERNS

REF 29 1.2M T BAR 4 LANTERNS

STAND TOPS

REF 14/2 TOP (M10)

REF 14/3 TOP (M12)

REF 22 T TOP TO TAKE 48MM BARREL

1.5M ALUMINIUM BARREL T-BAR

2M ALUMINIUM BARREL T BAR

REF 55 WIND UP STAND



£ 892.00

£ 300.00

£ 150.00

£ 22.00

£ 33.00

£ 22.00

£ 22.00

£ 65.00

£ 20.00

£ 30.00

FROM OTHER MANUFACTURERS

HAND RAIL CLAMP FOR FOLLOW SPOT T54410 TO CLAMP ON TO 48MM BAR

£ 358.00

BALL RACE FOLLOW SPOT SPIGOT T74200

£ 119.00

LDR FOLLOW SPOT STAND

£ 270.00



JTS R4 RADIO MICS CHANNEL 38 ITALIAN DESIGN - CHINESE IMPORT →

CASCADE ADU BUILT IN, AUTO-TUNE. BELT PACKS AND HEADBAND MICS, (4 RECEIVERS IN A 1U SPACE)		
4 WAY HEADBAND KIT		£ 2002.00
8 WAY HEADBAND KIT		£ 3984.00
12 WAY HEADBAND KIT		£ 5966.00
R4 4 WAY RECEIVER		£ 726.00
METAL BELT PACK RTBM		£ 253.00
HAND HELD MIC ONLY		£ 376.00
FRONT MOUNTED AERIAL SET 1 PER SET OF RADIO MICS		£ 20.00
HEADBAND MIC SMARTCORE 50T4 IN BEIGE OR BLACK		£ 50.00
JTS TIE CLIP MIC CM201 BEIGE OR BLACK		£ 66.00
JTS TIE CLIP MIC CM501 BEIGE OR BLACK		£ 40.00
TIE CLIP ONLY FOR CM501 OR CM201 BEIGE OR BLACK		£ 5.00
RADIO MIC TRANSMITTER WAIST BAND POUCH (TO GO UNDER COSTUME)		£ 15.00
FLIGHT CASE - YOUR CHOICE, SO PLEASE SEE PAGE 44		

12 WAYS OF RADIO MICS IN 3U,
.....THAT'S TINY !

FOR UHF MICS YOU WILL NEED A LICENCE FOR CHANNEL 38. PLEASE ASK FOR DETAILS.

NB: THE GOVERNMENT / OFCOM HAS DECIDED WE MUST USE CHAN 38 ON 606-614 MHZ, LICENCE REQUIRED! PLEASE ASK FOR DETAILS, NOT EXPENSIVE. CHAN 70 863-865 MHZ, 4 MICS MAXIMUM AVAILABLE, LICENCE FREE. IF YOU HAVE CHAN 69 MICS, 801-862 MHZ THIS WAS FORBIDDEN IN DECEMBER 2012 AND YOU NEED TO BUY NEW CHAN 38 MICS. THIS IS FOR 4G AND DIGITAL TV. YOU COULD BE FINED IF STILL USING CHANNEL 69 FREQUENCIES. STARTED BY LABOUR CONTINUED BY THE COALITION AND NOW THE CONSERVATIVE GOVERNMENT....JUBILATE ! THEY SAID IT WAS GOOD FOR JOBS ! IT WAS.....IN CHINA !

ALLEN AND HEATH MIXERS

ZED 22 I FX MIXER NON RACKMOUNT 16 MIC + 3 STEREO	£ 800.00
ZED 18 MIXER RACKMOUNT 12 MIC + 4 STEREO INCL RACKMOUNT KIT	£ 750.00
ZED 14 MIXER RACKMOUNT 6 MIC + 4 STEREO INCL RACKMOUNT KIT	£ 520.00



ZED 22 IFX



ZED 18



ZED 14

FBT AUDIO → E.U. MADE

VENTIS 206 450 WATT PASSIVE SPEAKER
HANGING BRACKET KIT VNX
AX 800 AMP 2 X 400 WATT AMPLIFIER (2U)





AX 800



£ 560.00
£ 80.00
£ 400.00

EXCITING PHOTO ISN'T IT....BUT A GREAT PRODUCT !

MICROPHONES

MINI SHOTGUN MIC (NEEDS PHANTOM POWER)		£ 100.00
MAXI SHOTGUN MIC (NEEDS PHANTOM POWER)		£ 140.00
SGM 14 SHOTGUN MIC (NEEDS PHANTOM POWER)		£ 275.00
SHURE SM 58 HAND HELD VOCAL MIC (EXCL. CABLE)	"FRED, THE LAMP'S SINGING AGAIN"	£ 125.00
JTS NX 8.8 HAND HELD VOCAL MIC (EXCL. CABLE)		£ 84.00
AKG 547BL BOUNDARY MIC (NEEDS PHANTOM POWER)		£ 420.00
JTS TX-8 HAND HELD VOCAL MIC (EXCL. CABLE)		£ 48.00
OR BUY 6 OR MORE TX-8....JUST £ 40.00 EACH		
MICROPHONE CLIPS INCL ADAPTERS 20-27 / 26-30 / 28-35 STAN 83/84/85+STAN 81		£ 5.00

PROEL

GUIDE PRICES REVISED APRIL 2023 AND CUSTOMS CHARGES WILL APPLY ! - BREXIT !

MIXERS

E.U. MADE

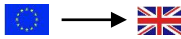

ALL STOCK COMES FROM ITALY AS U.K. BRANCH IS CLOSED.

PROEL MQ16USB 8 MIC+ 4 STEREO /12 MIC, 24 EFFECTS, 4 AUX, USB REC INCL RACKMOUNT KIT £ 500.00



PROEL MQ12 MIXER 4 MIC +2 STEREO PLUS EFFECTS £ 250.00

PROEL MQ10 MIXER 2 MIC +2 STEREO NOT RACKMOUNTABLE PLUS EFFECTS £ 150.00

AMPLIFIERS

HPX 900 AMPLIFIER (2U) 2 X 250 WATT £ 325.00

HPX 1200 AMPLIFIER (2U) 2 X 300 WATT £ 375.00

HPX 2400 AMPLIFIER (2U) 2 X 450 WATT £ 500.00

SPEAKERS

PROEL LITE SERIES PASSIVE (NEEDS AN AMPLIFIER) WOODEN CABINET

LTP 8 150 WATT SPEAKER £ 250.00

LTP 10 250 WATT SPEAKER £ 300.00

LTP 12 300 WATT SPEAKER £ 390.00

PROEL LITE SERIES ACTIVE (AMPLIFIER BUILT IN) WOODEN CABINET

LTP 8A 150 WATT SPEAKER ACTIVE £ 325.00

LTP 10A 250 WATT SPEAKER ACTIVE £ 395.00

LTP 12A 300 WATT SPEAKER ACTIVE £ 480.00

SPEAKER BRACKETS WALL MOUNT ADJUSTABLE KP560 / BRAC 02 £ 40.00

HANGING BRACKET FOR LTP 8 £ 43.00 LTP 10 £ 53.00 LTP 12 £ 70.00

SPEAKER STAND SPSK300 BLK STAN 01 £ 55.00

SPEAKER SAFETY BOND INCL EYE BOLT RING PLATE AND EYE RAWLBOLT FOR ALL SPEAKERS £ 40.00

PROEL WD10AV2 ACTIVE SPEAKER / FOLDBACK WEDGE 250 WATT £ 300.00

STUDIO SYSTEMS FROM OTHER SOURCES

ZENITH 110 SPEAKER 250 WATT SPEA 51 £ 216.00

SPEAKER BRACKET FOR ABOVE BRAC 02 £ 24.00

PSR8 ACTIVE SPEAKER 120W INCL BRACKET PER PAIR £ 329.00

PSR8 PASSIVE SPEAKER 120W INCL BRACKET PER PAIR £ 279.00

EPX 500 AMPLIFIER 250W PER CHANNEL AMP 25 £ 135.00

RCF F24XR 18 MIC 4 STEREO INPUTS **NOT RACK MOUNTABLE** £ 720.00

ALTO 2004 MIXER 18 MIC 2 STEREO INPUTS **NOT RACK MOUNTABLE** £ 560.00

SM12 FOLDBACK MONITOR PASSIVE (NEEDS AN AMPLIFIER) £ 295.00

SIGNAL EQUIPMENT AND ACCESSORIES

SINGLE MIC PHANTOM POWER SUPPLY OLH050 £ 50.00

COMPUTER TO MIXER CABLE 3M (3.5MM STEREO JACK- 2 MONO JACK 6.3MM) £ 20.00

I-POD TO MIXER CABLE 1.5M £ 18.00

¼" JACK - PHONO ADAPTER £ 3.00

¼" JACK - 3POLE FEMALE XLR 10M £ 20.00

DFS 2 WAY SPEAKER SWITCH FOR SPEAKERS IN 2 AREAS (A OR B OR A+B) £ 150.00

MULTICORE CABLES

3M 8 WAY 3 POLE XLR STAGE SNAKE PLUGS TO SOCKETS TER £ 40.00

25M 8 WAY 3 POLE XLR STAGE DRUM CABL 194 £ 97.00

10M 12 WAY 3 POLE XLR STAGE SNAKE CABL 201 £ 80.00

15M 8/4 WAY 3POLE XLR STAGE SNAKE CABL 202 £ 100.00

30M 8/4 WAY 3 POLE XLR STAGE SNAKE CABL 203 £ 160.00

30M 16/4 WAY 3 POLE XLR STAGE SNAKE CABL 204 £ 235.00



MIC STANDS

ROUND BASE MIC STAND (BLACK METAL OR RUBBER BASE) **BOOM MICROPHONE STAND** (BLACK)
SHORT BOOM MICROPHONE STAND (BLACK) **ALL VERSIONS *NEW LOWER PRICE*** £ 25.00

PLAYERS

AUDIOPHONY MP130BT CD / MP3 / USB / SD / DAB / BLUE TOOTH PLAYER (1U) £ 390.00
RACKMOUNT ... DOES EVERYTHING EXCEPT RECORDS, REEL TO REEL TAPE OR...WAX CYLINDERS !
DMP 50 CD / MP3 PLAYER (1U) INCLUDES RACKMOUNT KIT £ 220.00
NEWHANK DVD PLAYER (1U) MULTI-FORMAT INCL RACKMOUNT KIT £ 325.00

SOUND EFFECTS CD'S

1000 EFFECTS! PLUS A BONUS CD OF "WEIRD SCENE CHANGE MUSIC"..... ALWAYS HANDY !

SOUND EFFECTS. *THE DFS CD LIBRARY*, 10 CD'S WITH 100 EFFECTS EACH ! £ 50.00



**1000 SOUND EFFECTS! FOR £ 50 !
COMPUTER SOUND EFFECTS ARE
SECOND BEST.....HAVE OUR CD'S**

OUTDOOR SOUND PRODUCTS IP55

EXCITING PHOTOGRAPHS ! ... NOT.....BUT SUCH GOOD PRODUCTS.



SHADOW 108 8" SPEAKER IP55 RATED 225 WATTS 90° X 90° TOP £ 920.00
SHADOW 112 HC 12" IP55 RATED 600 WATTS 90° X 90° TOP INCL SUB ! £ 1400.00

AND HAVING MADE ALL THIS NOISE.....WE NEED TO CONTROL IT.

ACCOUSTIC PANELS

THE DESIGN OF MOST SCHOOL HALLS AND DRAMA STUDIOS IS BOX WITH 6 HARD SURFACES WHICH REFLECT SOUND ALL OVER THE PLACE. TRY STANDING IN THE MIDDLE OF YOUR SPACE AND CLAP YOUR HANDS HARD ONCE AND LISTEN TO THE REVERB, IT COULD BE SEVERAL SECONDS. NOW MULTIPLY THAT BY THE LEVEL OF AN ORCHESTRA PLAYING AND IT BECOMES A CACOPHONY. ACOUSTIC PANELS DEADEN THE REVERB SO YOU HEAR SOUND AND NOT NOISE. *(MAY DEPEND ON THE QUALITY OF THE INPUT)*

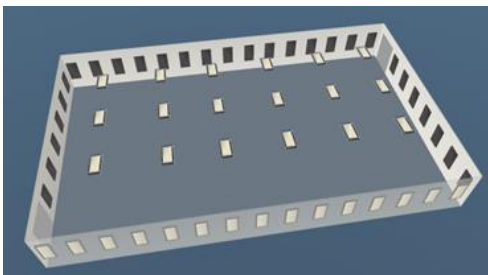

A VISUALISATION OF A LAYOUT



OUR SMALL DEMO PANEL

THE PANELS COME IN BLACK OR GREY, 1200 X 600 X 50MM THICK OR 600 X 600 X 50MM ALSO 1200 X 300 X 25MM , 300 X 300 X 25MM THICK. THE 25MM IS GOOD FOR TOP END AND 50MM IS GOOD FOR LOW FREQUENCIES.

EASILY SUSPENDED ON "VLADS" *(CALL ME AND ASK ME WHY THEY ARE CALLED THAT)*

EACH JOB IS DIFFERENT AND WE WOULD NEED TO DO AN INDIVIDUAL QUOTE AS THERE ARE SO MANY VARIABLES. **SITE VISITS ARE FREE.**

CALL DAVID 01322 350 351



HARDWARE PRICES REVISED JUNE 2024 **BRITISH MADE** 

HOOK CLAMP (SILVER OR BLACK) T20101	£ 10.00
SAFETY BOND 15KG 770MM (END 1 SOFT EYE, END 2 CARBINE HOOK)	£ 10.00
LONG HOOK CLAMP (225MM) T2010501 (FOR MOVING LIGHTS)	£ 15.00
BOLT SET M10 X 30 OR 1 3/4" X 3/8 TH WHITWORTH	£ 2.00
50 KG SAFETY BOND WITH 8 X 80MM CARBINE HOOK EACH END	£ 35.00
SPEAKER SAFETY BOND 50 KG WITH SCREWGATE KARABEENERS INCL FIXINGS	£ 40.00
CEILING SADDLE T30700	£ 10.00
UNIVERSAL CLAMP T30400	£ 10.00
"813" STAND OFF BRACKET T33000	£ 22.00
BOOM ARM TWISTED T30500 OR STRAIGHT T30600	£ 15.00
48 mm ALUMINIUM BAR (PER METRE)	£ 15.00
BIG BEN CLAMP T58108	£ 63.00
HEAVY DUTY GIRDER CLAMP T29800 (100-150MM) OR T29801 (150-200MM)	£ 70.00
TANK TRAP BASE	£ 183.00



PLUGS AND SOCKETS **BRITISH MADE** 

15 AMP PLUG PERMAPLUG	£ 6.50
15 AMP SOCKET PERMAPLUG	£ 7.50
GRELCO 15A	£ 7.00
13 AMP PLUG	£ 4.00
13 AMP SOCKET	£ 5.00
MK 843 ALM 15 AMP METAL SOCKET	£ 25.00
MK DOUBLE 13 AMP METALCLAD SOCKET	£ 30.00
13 AMP TENBY INSERT	£ 5.00
POWERCON GREY PLUG	£ 9.00
5 AMP PLUG PERMAPLUG	£ 8.00
5 AMP TRAILING SOCKET BG	£ 12.00
16 AMP PLUG	£ 3.00
16 AMP TRAILING SOCKET	£ 4.00
32 AMP PLUG	£ 18.00
32 AMP TRAILING SOCKET	£ 20.00
32 AMP WALL SOCKET	£ 25.00
63 AMP PLUG	£ 92.00
63 AMP TRAILING SOCKET	£ 95.00
63 AMP CHASIS SOCKET	£ 93.00
63 AMP WALL SOCKET	£ 95.00

GOSH, HOME-MADE LANTERNS
I DIDN'T THINK I'D EVER SEE
THAT. IT'S SO UNSAFE!

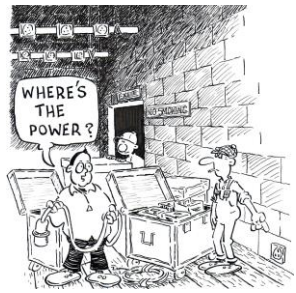
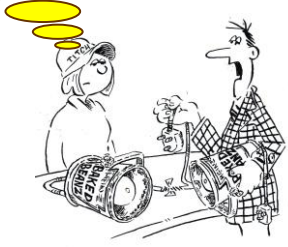

CABLES (PER METRE) **BRITISH MADE** 

HO5 RR 2 CORE	1.5mm	£ 2.50
HO5 RR 3 CORE	1.5mm	£ 4.00
HO5 RR 4 CORE	1.5mm	£ 5.00
HO5 RR 3 CORE	6.0mm	£ 10.00
HO7 RR 3 CORE	10.0mm	£ 16.00
SILICON 3 CORE	1.5mm (HEAT RESISTING)	£ 8.00
8 PIN DIN CONTROL CABLE		£ 5.00
FP200 1.5 3 CORE WHITE		£ 4.00
FP200 1.5 3CORE BLACK		£ 6.00
FP TERMINATIONS		£ 3.00



CONTROL TIE LINES

CAT 5 4 PAIR CONTROL CABLE	£ 5.00
4 WAY 3 POLE END BOX DMX OR SOUND	£ 70.00
SINGLE DMX OR SOUND END BOX	£ 40.00
DOUBLE DMX OR SOUND END BOX	£ 50.00



SPEAKON CABLES AND POWERCON CABLES (MADE UP IN 1.5MM, 2 OR 4 CORE, H05RR CABLE M-M)

LENGTH	2 CORE 1.5MM H05	4 CORE 1.5MM H05	POWERCON 3 CORE 1,5MM
1M	N/A	N/A	£ 28.00
1.5M	£ 15.00	£ 22.75	£ 31.00
5M / 6M	£ 20.00	£ 27.50	£ 38.00
10M	£ 26.20	£ 33.50	£ 40.00
20M	£ 34.20	£ 45.50	£ 45.00
25M	£ 38.20	£ 51.50	£ 50.00



MAINS CABLES PRICES REVISED SEPTEMBER 2023

LENGTH	13 AMP 1.5MM 3CORE H07	15 AMP 1.5MM 3CORE H07	16 AMP 1.5MM 3 CORE H07
5M	£ 34.00	£ 39.00	£ 32.00
10M	£ 49.00	£ 50.00	£ 47.00
20M	£ 79.00	£ 85.00	£ 77.00
25M	£ 94.00	£ 99.00	£ 92.00

MULTI WAY CABLES (13 AMP) **DIRECT IMPORT FROM CHINA** →

- 13 AMP 8 WAY 10M SWITCHED BLOCK (WILL TAKE "FAT PLUGS" SIDE BY SIDE) £ 30.00
- 13 AMP 2 WAY 10M CABLE £ 18.00
- 13 AMP 5M CABLE 4 WAY £ 10.00
- 13 AMP 2M CABLE 4 WAY £ 8.00

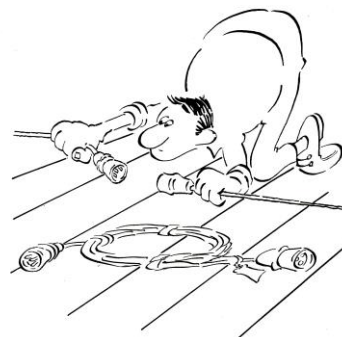

SOCAPEX (MADE UP IN 1.5MM CABLE) **BRITISH MADE**

- 5M SOCAPEX CABLE £ 130.00
- 10M SOCAPEX CABLE £ 150.00
- 25M SOCAPEX CABLE £ 220.00
- 15 AMP MALE SOCAPEX SPIDER 1M £ 150.00
- 15 AMP FEMALE SOCAPEX SPIDER STANDARD 1M £ 170.00
- 15 AMP FEMALE SOCAPEX SPIDER STAGGERED 1M-6M £ 180.00

GUIDE PRICES ONLY - FLUCTUATIONS ON COPPER PRICE.

CONTROL CABLES **DIRECT IMPORT FROM CHINA** → ON 3 AND 5. 4 & 8 **BRITISH MADE**

LENGTH	3 POLE XLR MICROPHONE/DMX	5 POLE XLR DMX BLACK	4 POLE XLR SCROLLER ETC	8 PIN DIN M-F OR M-M
1M	£ 10.00	£ 12.50	£ 38.00	£ 35.00
2M	£ 11.00	£ 14.00	£ 39.00	£ 36.00
3M	£ 12.00	£ 15.00	£ 41.00	£ 38.00
5M	£ 13.00	£ 17.00	£ 43.00	£ 40.00
10M	£ 15.00	£ 22.00	£ 48.00	£ 45.00
20M	£ 20.00	£ 32.00	£ 53.00	£ 50.00
30M	£ 48.00 <small>SPECIAL</small>	£ 42.00	£ 68.00	£ 65.00

ADAPTORS

- DMX 3-5 / 5-3 POLE OR DMX TERMINATOR, SPEAKON BARREL JOINER £ 6.00
- 3 POLE XLR PHASE REVERSE CABLE DMX £ 6.00
- ADAPTORS 13-15 A £ 16.00, 13-16 A £ 12.00, 5-15 A £ 19.00, 13A-POWERCON £ 24.00
- ZERO- PULSAR ADAPTOR M-M OR M-F 8 PIN DIN £ 32.00
- COMPUTER - MIXER CABLE 3M (3.5MM STEREO JACK - 2 1/4" JACKS) £ 20.00
- 1/4" JACK - PHONO ADAPTOR £ 3.00
- I-POD TO MIXER CABLE 1.5M (3.5MM STEREO JACK - 2 PHONO, ADD ADAPTORS)) £ 15.00
- 13AMP TO POWERCON 3M CABL250 £ 20.00
- 1.5M POWERCON GREY – BLUE CABLE CABL230 £ 28.00
- GREY TO BLUE POWERCON IN LINE CONNECTOR BOX CONN 05 £ 21.00
- GREY POWERCON – IEC FEMALE 2M CABL 259 AND PLUG £ 28.00



TOOLS (WHERE APPROPRIATE, BATTERIES NOT INCLUDED, SEE PAGE 53) MOSTLY E.U.

LEXMAN LED TORCH (3 AA BATTERIES) 10°- WIDE - APP 30M THROW !	£ 25.00
CRAFT KNIFE (AUTOMATICALLY RETRACTING BLADE FOR SAFETY)	£ 8.00
12" STEEL RULE	£ 4.00
12" TRIANGULAR SCALE RULE	£ 5.00
CHINAGRAPH PENCIL	£ 1.50
8" ADJUSTABLE SPANNER	£ 8.00
13 mm CRANKED SOCKET SPANNER (M8)	£ 8.00
17 mm CRANKED SOCKET SPANNER (M10)	£ 8.00
19 mm CRANKED SOCKET SPANNER (M12)	£ 8.00
21 mm CRANKED SOCKET SPANNER (SCAFF CLAMP)	£ 8.00
KNEE PADS (PAIR)	£ 12.00
WINGNUT SPANNER WITH 10 OTHER FUNCTIONS	£ 20.00

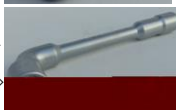

WOULD THE LEFT HAND TELL THE RIGHT HAND WHAT IT IS DOING !

PAT TESTING

DON'T FORGET YOU NEED TO HAVE YOUR EQUIPMENT CLEANED AND PAT TESTED REGULARLY (LEGAL REQUIREMENT). WE SUGGEST ANNUAL, TO KEEP IT IN TIP-TOP CONDITION. PLEASE ASK US FOR A SERVICE VISIT AND..... GET A PROPER JOB ! NOT A STICKERING EXERCISE WHICH IS POINTLESS AND DANGEROUS ! THEY DON'T FIND ANY FAULTS...UNTIL IT IS TOO LATE. WE FIND ANY FAULTS.... AND FIX THEM. CALL DAVID 01322 350 351



CLEAN AND PAT TEST



1 DOWN..... ONLY 199 TO GO !FUN !

TEMPORARY FIXINGS

RESEALABLE CABLE TIES	100 No 250mm LONG X 7.5mm WIDE	£ 6.25
STICKY CABLE CLIPS	100 No TAKES UP TO 18mm CABLE	£ 12.00

FUSES

32mm 10AMP (ACT 6, PULSAR, BETA PACK ETC)	OR LC10 10AMP (MINI 2 ETC)	£ 1.00
20mm 5 AMP HRC (PULSAR MINIPACK / ZERO88 ALPHAPACK)		£ 0.80
ALPHA PACK FUSE CAPS (<u>THE</u> ORIGINAL PART AS <u>NO</u> OTHER WILL FIT)		£ 6.00



FIRE-PROOFING FLUID **BRITISH MADE** 

WE CANNOT SEND PAINTS OR FLUIDS BY POST BECAUSE, IF THEY LEAK THE RESULTANT INVESTIGATION IS VERY DIFFICULT AND EVERYONE IS UNHAPPY !

- FLAMECHECK PLUS 1 LITRE (ALL MATERIALS)
- FLAMECHECK PLUS 5 LITRE (ALL MATERIALS)
- FLAME BAR PE 6 5 LITRE (SYNTHETIC FABRICS)



- £ 22.00
- £ 75.00
- £ 75.00

FIRE PROOF THE SET, NOT THE ACTORS !

WE CAN EMAIL THE VIDEO CLIP

SCENIC PRODUCTS **PRICE PER LINEAR METRE**

- RED/SAND BRICK CLOTH 1.5M WIDE (APP 2/3 FULL SIZE) £ 18.00
- LIGHTER BRICK CLOTH 1.5M WIDE (APP 2/3 FULL SIZE) £ 18.00
- STONE CLOTH 1.5M WIDE THINK CASTLE WALLS £ 18.00
- ROCK CLOTH 1.5M WIDE £ 18.00
- STRAW CLOTH 1.5M WIDE THATCHED ROOF EFFECT £ 18.00
- WOOD EFFECT CLOTH 1.5M WIDE (SHED STYLE) £ 18.00
- CADIZ WOOD WEAVE 1.5M WIDE (BAMBOO FENCE STYLE) £ 18.00
- COTE D'AZUR 1.5M WIDE (WATER EFFECT) £ 18.00
- HIGHLAND GRASS CLOTH 1.5M WIDE £ 18.00
- YORK IVY CLOTH 1.5M WIDE £ 18.00
- HARLEQUIN CLOTH 1.5M WIDE £ 18.00
- SPOTTY CLOWN 1.5M WIDE £ 18.00
- TARTAN 1.5M WIDE £ 18.00
- METAL 1.45M WIDE DURBAR CHEQUER PLATE. £ 18.00
- BOTTLE GREEN MOULTON 1.3M WIDEDOING ROBIN HOOD ? £ 12.00
- CARMINE RED, BLUE OR YELLOW MOULTON 1.3M WIDE £ 12.00

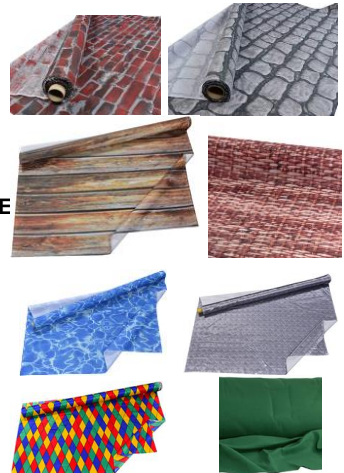

NEW... ALUSHAPE. DELIVERY FROM EUROPE IS EXTRA. POA. **CUSTOMS CHARGES WILL APPLY**
 ALUMINIUM FOIL BACKING WITH WHITE CRETONE COTTON CAN BE SHAPED BY HAND TO APPEAR AS ROCKS ETC FLAME RETARDANT. CAN BE PAINTED FOR EFFECT BUT LIT WELL, IT WILL GIVE DEPTH TO SCENERY 10M BOLT 1.25M WIDE £ 325.00



VERY SIMPLE TO WORK WITH, CAN BE MOULDED AND WITH THE MINIMUM OF SUPPORT, WILL LOOK SOLID.

PERFECT GRASS **DELIVERY IS EXTRA ! GUIDE PRICES . CUT TO LENGTH BY THE METRE.**

ARTIFICIAL "GRASS" FOR THE STAGE. LAY AS CARPET. COMES IN 2M OR 4M WIDE X 20M LONG BOLTS, CAN BE CUT WITH A CRAFT KNIFE. N.B.THESE PRODUCTS NEED FIREPROOFING. USE PE6 SEE ABOVE.

- SPRING 20MM PILE A (PE6) PER M² £ 25.00
- FERN 35MM PILE B MOST LUCIOUS (PE6) PER M² £ 35.00
- PALM 35MM PILE C LUCIOUS (PE6) PER M² £ 33.00
- OLIVE 20MM PILE D LUSCIOUS (PE6) PER M² £ 30.00



DANCE FLOOR **DELIVERY IS EXTRA! GUIDE PRICES ONLY. OTHER PERMANET FLOORING AVAILABLE.**

- HARMONY FLOOR MATT 2M X 25M MOST COLOURS £ 780.00
- HARMONY FLOOR GLOSS 1.5M X 25M MOST COLOURS £ 1280.00

FOLLOW SPOT 75 WATT LED CHINESE IMPORT FROM E.U.



75 WATT LED COOL WHITE 30628
COLOUR WHEEL AND DIMMER BUILT IN
PUSH BUTTON OPERATION, NO HEAT !
12 LEAF IRIS, INCLUDING STAND.
16°-20° 2-10M THROW 640 X 340 X 300 MM 5.9KG
AS BRIGHT AS A 250WATT MSD.....AND LESS THAN HALF THE PRICE !
IDEAL FOR PRIMARY SCHOOLS AND COMEDY CLUBS...ALL THIS FOR JUST....



£ 738.00



O.K. WHAT ARE YOU ????



DON'T YOU KNOW ? ...
I'M A FOLLOW SPOT !

STROBES (BRIGHT AND SIMPLE TO USE) PRICES REVISED SEPTEMBER 2023

DIRECT IMPORT FROM CHINA →

TITAN STROBE 1.5 Kw 4 CHAN DMX. 1-15 FLASHES PER SECOND (FPS) 40222 £ 235.00

UV

400 WATT UV GUN INCL LAMP ETC READY TO WORK (SPOTLIGHT MILANO) £ 256.00

EQUINOX 400 WATT UV GUN INCL LAMP £ 162.00

PAR CANS CP95 NOW DISCONTINUED....SHAME !

PAR 64 CAN WITH CP62 LAMP. BLACK OR SILVER, LONG OR SHORT OR FLOOR CAN.
INCLUDING 1Kw LAMP OF YOUR CHOICE CP 60, 61, 62 HOOK CLAMP, 15A PLUG, SAFETY BOND & COLOUR
FRAME, READY TO WORK. £ 120.00

SINGLE CHANNEL DIMMER

BOTE 32 SINGLE CHAN DIMMER IEC OUT, REMOTE SLIDER AND DMX. HANGING KIT INCL £ 75.00

ADAPTER IEC TO 15AMP £ 15.00

STAGE BRACES AND WEIGHTS

CARRIAGE IS EXTRA !NO, THEY CAN'T GO IN THE POST !
....THEY WON'T GO THROUGH THE LETTERBOX !

EXTENDING STAGE BRACE 2M-4M £ 85.00

STAGE WEIGHT 12.5 KG £ 45.00

MAGIC BLACK PAINT.... HATOSCREEN PROJECTION PAINT.

LOOKS BLACK, UNTIL YOU PROJECT ON TO IT. THEN CLEAR IMAGES WITH FULL
COLOUR ON THE BACKGROUNDI SAID IT WAS MAGIC,
MY "O" LEVEL PHYSICS CAN'T EXPLAIN IT ! THE IMAGE CAN BE SEEN FROM OBLIQUE
ANGLES, EVEN BETTER THAN PEPPER'S GHOST... **FOR YOUNGER READERS..... GOOGLE IT !**
MIRROR, MIRROR ON THE WALL ?OR THE GHOSTS FROM RUDDIGORE ?.....OR HARRY POTTER ? BLYTHE SPIRIT ?.....OR
WHEREVER YOUR IMAGINATION TAKES YOU.....
1 LITRE COVERS APP 6-8M². USING A ROLLER TO AVOID BRUSH MARKS. IT IS RECOMMENDED BLACK EMULSION AS AN
UNDERCOAT, THEN 2 COATS OF THE MAGIC PAINT, VIDEO CLIP COMING SOON TO THE WEBSITE.....

PER LITRE £ 100.00

CONTACTOR SYSTEM

GUIDE PRICES ONLY

60 AMP 1 PHASE CONTACTOR WITH KEY SWITCH WITHIN 10M £ 1650.00

60 AMP 3 PHASE CONTACTOR WITH KEY SWITCH WITHIN 10M £ 1800.00

100 AMP 1 PHASE CONTACTOR WITH KEY SWITCH WITHIN 10M £ 2000.00

100 AMP 3 PHASE CONTACTOR WITH KEY SWITCH WITHIN 10M £ 2100.00

SUBJECT TO SITE VISIT TO CONFIRM DETAILS **(SITE VISITS ARE FREE)**

PLEASE ASK HOW MUCH OF YOUR MONEY IS WASTED BY LEAVING THE SYSTEM ON AT ALL TIMES ...
YOU WILL BE SURPRISED ! PAYBACK TIME.....COULD BE ABOUT 6 MONTHS.



STAGING

BRITISH MADE 

ALL PLUS TRANSPORT ! GUIDE PRICES

STAGE BASE 2M X 1M X 120mm HIGH, PLYWOOD TOP, PAINTED BLACK	£ 438.00
STAGE BASE 1M X 1M X 120mm HIGH, PLYWOOD TOP, PAINTED BLACK	£ 327.00
STEELDECK 8' X 4' X 7" HIGH, PLYWOOD TOP, PAINTED BLACK	£ 636.00
SETS OF 4 LEGS (INCL "DINKLES") 12"	£ 30.00
18"	£ 36.00
24"	£ 44.00
30"	£ 52.00
36"	£ 60.00



STAGEBASE
45KG



STEELDECK

DINKLES EACH (PLASTIC END CAPS FOR LEGS..... NO, I DON'T KNOW WHY THEY ARE CALLED THAT) £ 0.80

DOUGHTY ENGINEERING **BRITISH MADE**

DOUGHTY EASY DECK 1M X 1M X 250 MM HIGH	£ 285.00
DOUGHTY EASY DECK 1M X 1M X 500 MM HIGH	£ 295.00
DOUGHTY EASY DECK 1M X 1M X 750 MM HIGH	£ 315.00
HAND RAIL 1M £ 110.00	HANDRAIL CORNER £ 120.00
STEPS DOUBLE SET 500MM £ 335.00	TRIPLE SET 750 MM £ 379.00



STAGE SYSTEMS **BRITISH MADE** **GUIDE PRICES**

Q BUILD 750MM X750MM X 227 HIGH	£ 192.00	
Q BUILD 750MM X750MM X 500 HIGH	£ 195.00	
Q BUILD 750MM X750MM X 722 HIGH	£ 207.00	
AND FOR TIERED SEATING		
Q BUILD 750MM X900MM X 227 HIGH	£ 210.00	
Q BUILD 750MM X900MM X 500 HIGH	£ 235.00	
Q BUILD 750MM X900MM X 722 HIGH	£ 260.00	
Q HANDRAIL SINGLE £ 140.00	CORNER £ 145.00	STEP HANDRAIL £ 107.00
STEPS 500MM DOUBLE STEP £ 220.00	DOUBLE STEP 722 MM £ 250.00	
CARPET - FACTORY FIT 750MM X 750MM ADD £40.00	900MM X 750MM ADD £ 45.00	
STORAGE DOLLY	£ 282.00	



AIRSTAGE "X10" DECK LEGS AS STAGEBASE ABOVE → **GUIDE PRICES**

2M X 1M PLYWOOD TOP PAINTED BLACK	£ 250.00
1M X 1M PLYWOOD TOP PAINTED BLACK	£ 225.00
2M X .5M PLYWOOD TOP PAINTED BLACK STEP	£ 225.00
1M X .5M PLYWOOD TOP PAINTED BLACK STEP	£ 212.00
LEG TO LEG CLAMP 2 WAY	£ 12.00
LEG TO LEG CLAMP 4 WAY	£ 25.00
DECK TO DECK CLAMP	£ 10.00
2M AIRSTAGE HANDRAIL INCL ADAPTERS	£ 190.00
1M AIRSTAGE HANDRAIL INCL ADAPTERS	£ 170.00
AIRSTAGE HANDRAIL ADAPTER 2 PER HANDRAIL	£ 25.00



PROJECTOR SEMAPHORE BLACKOUT SHUTTER

DON'T YOU JUST **HATE** IT WHEN A PROJECTOR IMAGE GOES OFF...BUT YOU CAN STILL SEE A "BLUE BLACKOUT", AN OXYMORON. **HERE** IS THE SOLUTION. THE UNIT SITS ON THE PROJECTOR AND IS TRIGGERED BY 1 CHANNEL OF DMX (5 POLE) AND BRINGS IN THE "FLAG" AND THE PROBLEM IS SOLVED ! £ 330.00



PROBLEM SOLVED !
JUST NEED TO FIX THE I.T. TECHNICIAN
AND THE "PING" OF THE LAPTOP....
PLEASE ASK US HOW

SMOKE FACTORY

GUIDE PRICES ONLY. APRIL 2023 BUT SUBJECT TO BREXIT AND COVID ALSO CURRENCY CHANGES

DATA 2 2.6KW MAX 240mL PER MIN DMX	£ 900.00
CAPTAIN D 1.3KW MAX 120mL PER MIN DMX	£ 600.00
SCOTTY BATTERY OPERATED 10 MIN FULL OR 150 BURSTS OF 5 SECS	£ 750.00
TOUR HAZER II DMX	£ 900.00
HAZE FLUID 5L	£ 43.00
STANDARD SMOKE FLUID 5L	£ 30.00
LONG LASTING SMOKE FLUID 5L	£ 30.00



**SPOT THE STAR TREK THEME ?
THE M.D. IS A TREKKIE.**

E.U. MADE  →  **GERMAN PRICES BUT GERMAN QUALITY ENGINEERING.**

PROFESSIONAL BATTERIES

PPROCELL MADE BY DURACELL

AAA OR AA	£ 0.75
C OR D	£ 3.00
PP3 9V	£ 3.00
CR 2032 3V COIN CELL CR 2016 CR 2025	£ 2.50
LR 44 / SR 44 COIN CELL	£ 2.50

**PLEASE DON'T USE "CHEAP" BATTERIES, THEY'RE NASTY !
WE SUPPLY INEXPENSIVE ONES WHICH ARE GOOD !**



ELECTRONIC FLICKER CANDLES

INTELLIGENT CANDLE RANGE DIRECT IMPORT FROM CHINA  → 

THESE CANDLES ARE DESIGNED TO FIT INTO STANDARD HOLDERS AND CANDELABRA, IDEAL FOR WEDDINGS AND FUNCTIONS AND WHERE REAL FLAMES ARE FORBIDDEN. THEY HAVE INTERNAL BATTERIES. THE FLAME IS THE SWITCH, PRESS DOWN TO SWITCH ON, THEN THE SAME TO SWITCH OFF. THERE IS LESS FLICKER THAN THE ELEGANCE RANGE BUT THEY LOOK GREAT!
SOME PEOPLE SEE THIS AS MORE REALISTIC, BUT INDIVIDUAL PERCEPTION IS EVERYTHING!

CANDLES

5 1/2" STANDARD CANDLE SC3741WW Ø16, LR44 COIN CELLS (40 HOURS)	£ 9.00
8" STANDARD CANDLE SC2711WW Ø20, 2 AA BATTERIES (200 HOURS)	£ 12.00
10" STANDARD CANDLE SC2713WW Ø20, 2 AA BATTERIES (200 HOURS)	£ 16.00
17" CHURCH CANDLE SC2770 Ø30, 2 AA BATTERIES (200 HOURS)	£ 20.00
10" WAFTING FLAME CANDLENEW...AND MOST REALISTIC !	£ 35.00



TEA LIGHTS SC3684WW

CLASSIC TEA LIGHT BUT BATTERY OPERATED, LR44 COIN CELLS (40 HOURS)
WITH FROSTED GLASS HOLDERS £ 8.00

CANDLE WAX PILLAR CANDLES SC3875A

5" HIGH X 3" DIA WAX CANDLE WITH CANDLE LAMP TEA LIGHT
2 AA BATTERIES (200 HOURS) £ 20.00

LUMINARA (PROFESSIONAL)

PILLAR CANDLE STATIC LED WAFTING FLAME
5" HIGH X 4" DIA WAFTING FLAME CANDLE
7" HIGH X 4" DIA WAFTING FLAME CANDLE
THE MOST REALISTIC.....YET!

5" HIGH X 3" DIA WAFTING FLAME CANDLE
7" HIGH X 3" DIA WAFTING FLAME CANDLE
9" HIGH X 3" DIA WAFTING FLAME CANDLE



AVAILABLE £ 70.00
COLOURS... £ 78.00
CRIMSON, SAGE
OR IVORY
MORE SIZES £ 45.00
AVAILABLE £ 53.00
SOON..... £ 60.00

2 AA BATTERIES FOR THESE APP 100 HOURS FROM STANDARD ALKALINE BATTERIES, CAN RUN ON RECHARGEABLE BATTERIES.



THREE PART LADDERS AND STEP LADDERS

WE ONLY SUPPLY CLASS 1 INDUSTRIAL PRODUCTS, PROFESSIONAL QUALITY NEVER DOMESTIC QUALITY !

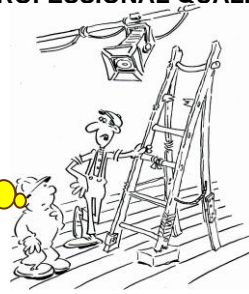

I'VE HAD THIS LADDER FOR 40 YEARS, WHAT'S WRONG WITH IT ? YOU AND ALL THIS.... "ELFIN SAFETY"PAH ! DO YOU THINK I'DE BE DAFT ENOUGH TO HAVE AN ACCIDENT ?

<u>TYPE</u>	<u>CODE</u>	<u>RUNGS TREADS</u>	<u>STORAGE HEIGHT/LENGTH</u>	<u>A FRAME HEIGHT</u>	<u>WORKING HEIGHT (A)</u>	<u>PRICE</u>
ZARGES	41538	3 X 8	2.45M	1.4M	4.1M	£ 550.00
ZARGES	41540	3 X 10	3M	2.4M	4.95M	£ 625.00
ZARGES	41542	3 X 12	3.55M	3.3M	6.1M	£ 762.00
ZARGES	41544	3 X 14	4.15M	4.3M	6.95M	£ 936.00
SWINGBACK STEPS	HB5B8	8	1.86M	1..68M	TBA	£ 188.00
SWINGBACK STEPS	HB5B10	10	2,34M	2.13M	TBA	£ 230.00
SWINGBACK STEPS	HB5B12	12	2.82M	2.56M	TBA	£ 267.00

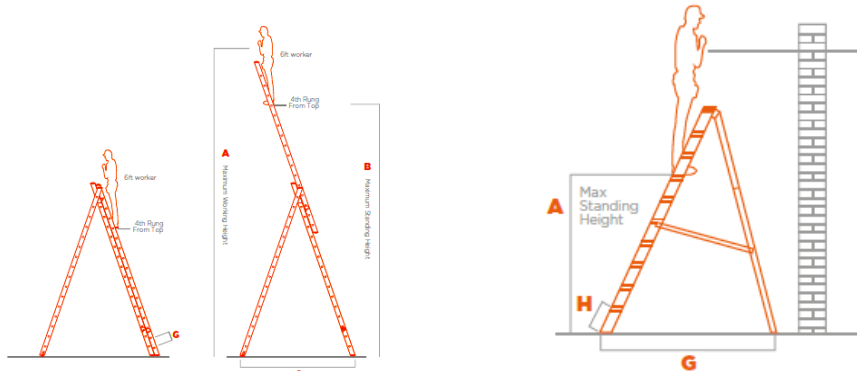

HILYTE TOWERS SINGLE WIDTH 500MM WIDE X 2.5M LONG



WORKING HEIGHT IS 2M ABOVE PLATFORM

HILYTE TOWER	4.2M TOP PLATFORM HEIGHT	£ 2860.00
HILYTE TOWER	4.7M TOP PLATFORM HEIGHT	£ 3500.00
HILYTE TOWER	5,7M TOP PLATFORM HEIGHT	£ 3745.00
HILYTE TOWER	6.2M TOP PLATFORM HEIGHT	£ 3800.00

YOU SHOULD HAVE PASMA TRAINING FOR TOWERS. A VERY INTERESTING COURSE. PLEASE ASK FOR INFORMATION

STANDARD MODELS

STOWAWAY MODELS

Model 50524

Model 50518

Model 50512

MODEL 9812

MODEL 9815

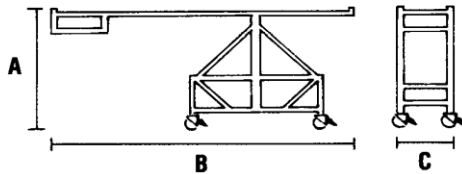
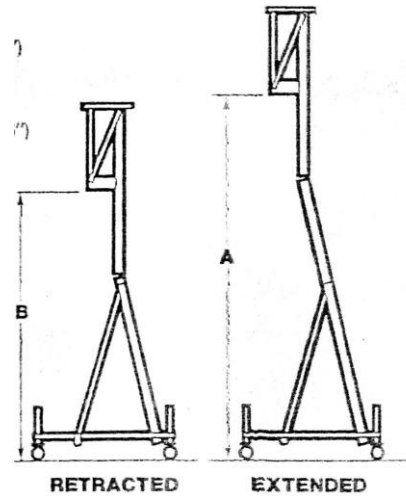
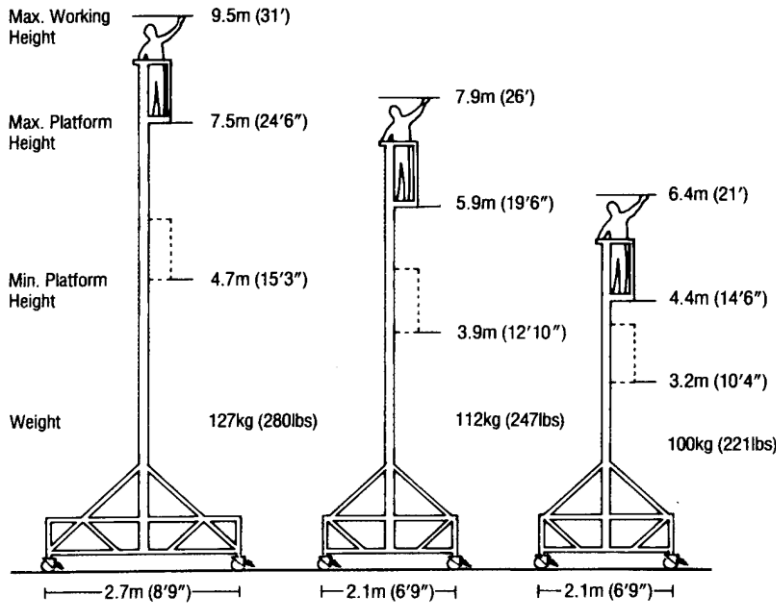

	A	B	C
50524	1.9m (6'4")	5.3m (17'6")	0.74m (2'5")
50518	1.9m (6'4")	4.6m (15')	0.74m (2'5")
50512	1.9m (6'4")	3.8m (12'6")	0.74m (2'5")

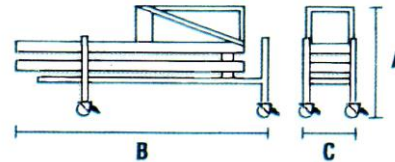

STOWED AWAY

STOWAWAY MODELS

	A	B	WORKING LOWEST	WORKING HIGHEST	STORAGE
9812	EXT 3.6M (12')	RET 2.4M (8')	4.5M (15')	5.7M (19')	A 1.1M B 2.5M C 0.74M
9815	EXT 4.58M (15' 3")	RET 3.38M (11' 3")	5.48M (18' 3")	6.68M (22' 3")	A 1.1M B 2.5M C 0.74M



TELL US THE HEIGHT OF YOUR GRID AND CEILING AND WE WILL ADVISE YOU ON THE SIZE. WORKING HEIGHT IS TAKEN AS 2M ABOVE PLATFORM LEVEL. ALSO, WE CAN DO THE MEASUREMENTS FOR YOU.

WORKING HEIGHT TO 9.5M (31 FT), PLATFORM CAPACITY 115KG (250LB), FULLY ADJUSTABLE LEGS, INCLUDING OUTRIGGERS. ALL ALUMINIUM CONSTRUCTION, COMPACT AND MANOEUVRABLE. ALL TALLESKOPE WILL FIT THROUGH A STANDARD SINGLE DOORWAY...GIVEN SPACE BEYOND THE DOOR. DELIVERY IS EXTRA AND WILL BE FROM LEIGH, LANCASHIRE. YOU WILL GET A FULL DEMONSTRATION OF THE TALLESKOPE. TALLESKOPE CANNOT BE SENT BY CARRIER OR POST !

NB

THE HSE HAVE NOW DECIDED THAT ALL TALLESKOPE MUST HAVE 2 SETS OF STABILIZERS IN USE AT ALL TIMES. YOU MUST HAVE TRAINING TO USE THEM AT ADDITIONAL COST APP £150 PER PERSON BASED ON MINIMUM 4 PEOPLE AND ALL TALLESKOPE MUST BE INSPECTED. THESE RULES ARE BEING DEVELOPED AND WE WILL KEEP YOU INFORMED ! THE ABTT PRESS RELEASE DOCUMENT IS ON OUR WEBSITE.

PRICES: MODEL 50512
MODEL 50518
MODEL 50524
MODEL 9812 STOWAWAY
MODEL 9815 STOWAWAY



DELIVERY IS EXTRA AND NO, WE CAN'T POST IT !

£ 4200.00
£ 4500.00
£ 4900.00
£ 4200.00
£ 4600.00
£ 725.00

FOR EXISTING TALLESKOPE, ESSENTIAL UPGRADE KIT. ADDITIONAL PAIR OF STABILIZERS ETC

ALSO SECOND HAND REFURBISHED STOCK IS OFTEN AVAILABLE. PLEASE ENQUIRE 01322 350 351



NEW..ISH PRODUCTS.....

**EQULED 357 1500 WATT HAZE MACHINE
FL06 FLUID (OUR STOCK HAZE FLUID)**

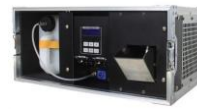

5 L £ 705.00
£ 17.00
£ 839.00

**ARCUS 2000 HEAVY FOG MACHINE
USES FL09 FLUID AND DISTILLED WATER
2800 CU FT PER MIN
FLIGHT CASE**



£ 300.00

**VAPOUR 1000 HAZE MACHINE 800 WATT DMX EQULED 360
FL06 FLUID (OUR STOCK HAZE FLUID)**



5 L £ 125.00
£ 17.00

**HP3000 SMOKE MACHINE (STAR BUY !)
3KW DMX AND MANUAL 60,000 CU FEET PER MINUTE !
IS THAT A BIG NUMBER ? " YOU BET YOUR SWEET BIPPY"
YOU HAVE TO BE OF AN AGE TO REMEMBER THAT LINE....ASK ME.**



£ 839.00

**BOTE 16 6 CHANNEL DMX DESK 3POLE DMX OUT
GREAT FOR A SMALL REMOTE DESK FOR THE ABOVE**



£ 60.00

NEW PRODUCTS OVER 18'S ONLY

VIKING MAROONS

SMALL .2g PER PACK OF 10
MEDIUM .5g PER PACK OF 10
LARGE 1.5g PER PACK OF 6



£ 100.00
£ 120.00
£ 48.00

MICRO FLASH POTS FOR OUR FLASH BANG WALLOP CAMERAS ETC EACH £ 10.00

HAUSMAN INVISIBLE UV PAINT

A GOOD RANGE OF COLOURS ALL OF WHICH ARE INVISIBLE IN NORMAL LIGHT AND THEN WHEN UV LIGHT IS APPLIED... SOLID VIVID COLOURS...MAGIC !

THINK PANTO ! IT'S JUST AROUND THE CORNER...OH YES IT IS !

RED, GREEN, BLUE, PINK, MAGENTA, ORANGE, YELLOW AND WHITE 500mL £ 85.00
TEST KIT 1 OFF EACH 8 X 40mL £ 90.00

INVISIBLE UV PAINT

Invisible Blue PAT343185	Invisible White Light PAT343475	Invisible Orange PAT343925
Invisible Green PAT343935	Invisible Pink PAT343945	Invisible Magenta PAT343965
Invisible Yellow PAT343975	Hausmann InVisible Ultraviolet Paint Produces high quality fluorescent	
Invisible Red PAT343985		

**ALADDIN'S JEWELLED CAVE...EASY !
ESPECIALLY IF YOU HAVE BOUGHT
PERFORMER HEXES FROM US,
THE U.V. IS BUILT IN ! SEE PAGE 61**

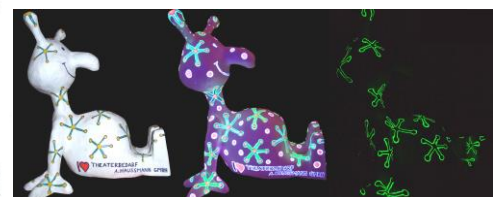

LED LIGHTING

PICTURES NOT TO SCALE !

IS IT THE WAY FORWARD ?..... AND WHY LED LIGHTING IN THEATRE AND DRAMA ?

- **LOW ENERGY CONSUMPTION, 70% SAVING OVER A GENERIC 650 WATT FITTING AND MORE LIGHT !**
- **ENVIRONMENTALLY FRIENDLY, MASSES OF LIGHT, COLOUR AND IMPORTANTLYLOW RUNNING COSTS !**
- **NO HEAT. NO U.V. (UNLESS BUILT IN) NO FILTER CHANGE. NO LAMP CHANGE.....SAVING TIME AND MONEY.**
- **50,000 HOURS LIFE EXPECTED, THAT IS 40 YEARS AT THEATRE USAGE (8 SHOWS PER WEEK, 3 HOURS PER SHOW, 52 WEEKS PER YEAR) A GENERIC FITTING COULD COST £ 2000 IN LAMPS AT TODAYS PRICES FOR THE SAME TIME..... THAT IS PER FITTING !.....BUT, 50,000 HOURS @ 24/7/365 = 5.7 YEARSSWITCH IT OFF AT NIGHT !...SIMPLES.**
- **GOOD COLOUR RENDITION, PRIMARY COLOURS, RED, GREEN, BLUE. SOME WITH WHITE, AMBER AND UV. OR LIME.**
- **WHITE ALLOWS PASTEL SHADES OF THE PRIMARY COLOURS AND AMBER GIVES A WARMER NOTE.**
- **FROM 1 CHANNEL OF DMX.....TO MANY MORE ! THAT IS WHY DESK SELECTION IS SO IMPORTANT.**
- **NO DIMMERS, AS THE DIMMERS ARE BUILT IN. DMX CONTROL ONLY. REQUIRES HARD POWER FROM C TYPE BREAKER.**
- **FAN COOLED, SO THERE IS SOME FAN NOISE BUT IT IS SIMILAR TO A COMPUTER FAN, DO WE NOTICE THIS AFTER A FEW SECONDS ? IT IS JUST PART OF THE BACKGROUND NOISE. SERVICING WILL INCLUDE A BLAST OF AIR TO CLEAR DUST USING AN AIR DUSTER AND PAT TESTING. A LEGAL REQUIREMENT AND GOOD PRACTICE. YOU HAVE TO MOT THE CAR....**

THEY WILL BE OF GREAT ADVANTAGE TO HAVE, WITH A MIXTURE OF CONVENTIONAL FITTINGS, USING EACH TO ITS BEST. WE COMPARE THE "COST TO VALUE" RATIO BEFORE RECOMMENDING EQUIPMENT. YOU WILL NEED A GOOD DMX DESK BUT THE PRICES ARE I BELIEVE REASONABLE. PEOPLES EXPECTATIONS HAVE MOVED ON FROM EVEN JUST A FEW YEARS AGO AND SO HAS TECHNOLOGY. THERE ARE MORE FITTINGS COMING ON THE MARKET ALMOST WEEKLY, PLEASE ASK FOR OUR LED BROCHURE.

BEWARE OF "CHEAP" FITTINGS AS THEY ARE OFTEN TOO SMALL, TOO NARROW, INEFFECTUAL..... AND WE WON'T SELL THEM..... WE WANT SATISFIED CUSTOMERS !

WILL THEY REPLACE CONVENTIONAL FITTINGS ?

NO., WELL MAY BE, POSSIBLY, PROBABLY, YES, BUT NOT JUST YET....ER..... I THINK.....OH ,HANG ON, YES, THEY'RE HERE ! EVEN THOUGH LONG LIFE ON LED YOU MUST CLEAN & MAINTAIN THEM, REGULARLY, DO YOU SERVICE AND MOT YOUR CAR ?WHY NOT ASK US TO DO THE STAGE LIGHTING ? WE DO A FULL SERVICE OF CLEANING AND PAT TESTING. CIRCUIT PROTECTION MUST BE TYPE C BREAKERS AND YOU NEED DMX SPLITTERS AND TERMINATORS, THESE STOP UNWANTED DMX FLUCTUATIONS.

CONTROL CABLES

DIRECT IMPORT FROM CHINA  → 

LENGTH	3 POLE XLR MICROPHONE/DMX	5 POLE XLR DMX BLACK	13 AMP 4 WAY	COMBI CABLE IEC AND 3 POLE XLR	POWERCON BLUE-GREY WITH 3 POLE DMX COMBI
1M	£ 10.00 214	£ 12.50 183			£ 38.00 220
2M	£ 11.00 10	£ 14.00 185	£ 8.00		
3M	£ 12.00 179	£ 15.00 186		£ 22.00 174	£ 45.00 221
5M	£ 13.00 11	£ 17.00 187	£ 10.00	£ 33.00 175	£ 51.00 222
10M	£ 15.00 12	£ 22.00 188		£ 58.00 176	£ 71.00 223
20M	£ 20.00 13	£ 32.00 189			
30M	£ 24.00 180	£ 50.00 SPECIAL			
50M	£ 70.00 SPECIAL	£ 75.00 SPECIAL			

DMX SPLITTERS

AND ASSOCIATED ITEMS ALL REQUIRE MAINS SUPPLY NON DIM. PRICES REVISED SEPTEMBER 2023

A	2 IN 6 OUT 3+5 POLE 19" RACKMOUNT	DMS 26	£ 190.00
B	1 IN 6 OUT 3 AND 5 POLE DMX RACKMOUNT	BOTE 63	£ 110.00
C	1 IN 4 OUT 3+5 POLE 19" RACKMOUNT 1U	DB1-4 50780	£ 141.00
D	1 IN 8 OUT 3 POLE DMX IN AND OUT	BOTE 71 WALLMOUNT OR HOOK CLAMP	£ 100.00
E	1 IN 2 OUT 3 POLE LOOSE BOX	MINI DMX SPLITTER OR BOTE 72	£ 50.00
UPS	UNINTERUPTABLE POWER SUPPLY TO PROTECT DESK	GUIDE PRICE	£ 100.00
F	WIRELESS DMX TRANSIEVER F1-G6	BLACK BOX	£ 859.00
G	WIRELESS DMX MINI TRANCEIVER TO GO WITH F1- G6	(1 PER POSITION)	£ 421.00

PLEASE NOTE, WHEN SETTING THE DMX ADDRESS OF EACH FITTING DO IT WITH THE DMX CABLES DISCONNECTED AT THE FITTING YOU ARE WORKING ON. THEY CAN GET EASILY CONFUSED AND NOT DO WHAT YOU TELL THEM TO ! PLEASE READ ON FOR MORE INFORMATION. ALL PRODUCTS COMING IN FROM EUROPE INCLUDING THE CHINESE AND MOST AMERICAN PRODUCTS, ARE SUBJECT TO PRICE CHANGES. THIS IS DUE TO IMPORT TAXES AS A RESULT OF THE BREXIT VOTE AND COVID 19..... AND SHIPPING COSTS.



ALL LANTERNS ARE SUPPLIED READY TO WORK I.E. WE PUT IT TOGETHER WITH BRITISH HOOK CLAMP, BOLT SET AND SAFETY BOND ETC NOT CHEAP CHINESE IMITATIONS AND NOT AS A BAG OF BITS. A PROPER JOB !

VIRTUOSO 1000

ELUM 132

240 WATT PROFILE SPOT. RGBA AND LIME. WITH 6/7/8/11 OR 19 CHANNELS OF DMX ON 3 AND 5 POLE. POWERCON IN AND OUT. CHOICE OF LENS AS SOURCE FOUR WHICH ARE SO FAMILIAR TO US. 19°, 26°, 36°, 50° OR ZOOM VERSIONS, 15°- 30° OR 25°- 50°. RDM. ADJUSTABLE COLOUR TEMPERATURE, 2700°- 8000°K ON WHITE. SMOOTH DIMMING, ...NO DROP OFF ! EQUIVALENT TO A SOURCE FOUR 750 BUT WITH MORE COLOUR !



- 5 COLOUR BODY ONLY £ 1046.00
- HEX BODY ONLY £ 1150.00
- FIXED LENS BARRELS £ 210.00
- ZOOM LENS BARRELS £ 494.00
- FIXED LENS VERSIONS COMPLETE
 - OUR PRICE** 5 COLOUR FIXED £ 1250.00
 - OUR PRICE** 6 COLOUR FIXED £ 1360.00
- ZOOM VERSIONS COMPLETE
 - OUR PRICE** 5 COLOUR ZOOM £1540.00
 - OUR PRICE** 6 COLOUR ZOOM £1644.00
- IRIS DIAPHRAGM £ 65.00
- SPECIAL ANGLE LENS 5°,10°,14° £ POA

VIRTUOSO 1000 HEX

ELUM 143

MUCH AS ABOVE BUT WITH CYAN AS WELL JUST A FEW MORE CHANNELS OF CONTROL AND COLOUR TEMPERATURE UP TO 10,000° ON WHITE.

VIRTUOSO 600

ELUM 134

150 WATT PROFILE SPOT. RGBA AND LIME. WITH 3/7/10/12/OR 18 CHANNELS OF DMX ON 5 POLE, POWERCON IN / OUT. 25°-50° . ADJUSTABLE COLOUR TEMPERATURE ON WHITE 1800° – 10,000° K (CANDLE LIGHT TO POLAR DAYLIGHT)
 48 PRESET COLOURS AVAILABLE
 480 X 320 X 233MM
 SMOOTH DIMMING NO DROP OFF ! EQUIVALENT TO A SOURCE FOUR JUNIOR ZOOM AND ABOUT THE SAME SIZEBUT WITH MORE COLOUR AND 70% LESS POWER !

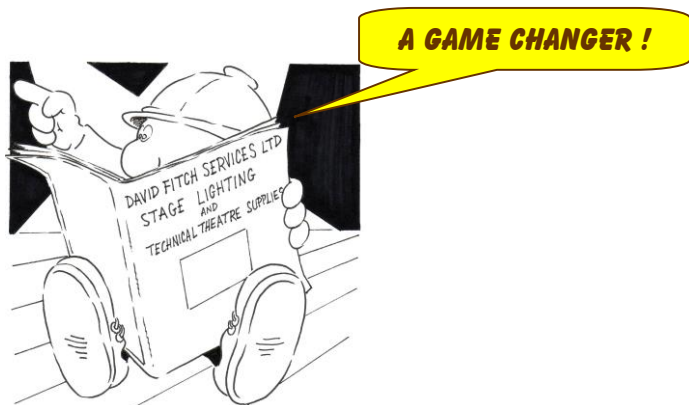

- COMPLETE LANTERN £ 996.00
- BUT OUR PRICE** £ 800.00

VIRTUOSO 2000

ELUM 135

220 WATT FRESNEL. RGBA AND LIME. WITH 8/10/13 OR 19 CHANNELS OF DMX ON 3 AND 5 POLE. POWERCON IN AND OUT. 15°- 45° . ADJUSTABLE COLOUR TEMPERATURE, ON WHITE 2700°- 8000°K. BARNDOORS INCLUDED. MOTORISED ZOOM. RDM. 175MM LENS. SMOOTH DIMMING, NO DROP OFF. ADDITIONAL FLAPS ON BARNDOOR TO FILL IN THE GAPS LEFT ON CONVENTIONAL BARNDOORS. SMOOTH DIMMINGNO DROP OFF !



**MORE ARTISTIC PHOTOS
TO FOLLOW.....**

LANTERN AND BARDOORS COMPLETE £ 900.00

MP 180 FRESNEL

ELUM 112



STAR PRODUCT

180 WATT RGBALC RED, GREEN, BLUE, AMBER, LIME AND CYAN SO VERSATILE !
13°-46° MANUAL ZOOM. COLOUR TEMPERATURE ADJUSTMENT 2800°K-8000°K ON WHITE.
POWERCON IN / OUT 1,5, 6, 8 OR 16 CHANNELS DMX ON 3 / 5 PIN IN AND OUT
SAME SIZE AND OUTPUT AS A SOURCE FOUR FRESNEL 145mm LENS (SMALLER THAN A PATT 743) BUT WITH SO MUCH COLOUR !
SOLID CONSTRUCTION 8.7 KG 371 X 300 X 318mm
PERFECT DIMMING.... NO DROP OFF !

OUR PRICE LANTERN AND BARNDOORS COMPLETE £ 700.00

THE BEST THING SINCE SLICED BREAD ?

MP 75 FRESNEL MK2

ELUM 105

75 WATT RED, GREEN, BLUE AND WHITE FRESNEL. 10°-50° MANUAL FOCUS. 4, 5 OR 7 CHANNELS OF 5 POLE DMX. CAPTIVE CABLE. **SIMILAR SIZE AND OUTPUT TO A QUARTET FRESNEL BUT WITH SO MUCH COLOUR !**
SOLID CONSTRUCTION. PERFECT DIMMING... NO DROP OFF !

OR IS THIS THE BEST THING SINCE SLICED BREAD ?

SUPER !

OUR PRICE £ 280.00



PERFORMER 18 HEX LEDJ 252B **DIRECT IMPORT FROM CHINA**  → 

18 X 12 WATT HEX LED 40° RGBWAUV
3 POLE DMX 6 OR 10 CHANNELS
CAPTIVE POWER CABLE

OR IS THIS THE BEST THING SINCE SLICED BREAD ?



£ 250.00

PERFORMER 18 ZOOM LEDJ 252D

18 X 8 WATT QUAD LED 25°-75° RGBW
3 POLE DMX 6 OR 8 CHANNELS
CAPTIVE POWER CABLE

STAR PRODUCTS !
AS BRIGHT AS
A 1KW FRESNEL !
...AND COLOUR



£ 250.00

PERFORMER 18 QUIN LEDJ 252A

18 X 10 WATT QUIN LED 40° RGBWA
3 POLE DMX 5 OR 9 CHANNELS
CAPTIVE POWER CABLE



£ 225.00

PERFORMER 18 QUAD LEDJ 252

18 X 8 WATT QUAD LED 40° RGBW
3 POLE DMX 4 OR 8 CHANNELS
CAPTIVE POWER CABLE



£ 200.00

PERFORMER 200 COB RGBW LEDJ 490

200 WATT COB RGBW
120° (2M SPREAD FOR EVERY 1M OF THROW, **THAT'S WIDE**)
3 POLE DMX 4 OR 8 CHANNELS
POWERCON IN / OUT



£ 200.00

NINJA ZOOM 250 LEDJ 195 **DIRECT IMPORT FROM CHINA**  → 

40 WATT RGBW PINSPOT 4°-29° MOTORISED ZOOM
POWERCON IN / OUT
5/7/11 CHANNELS ON 3 POLE DMX
GOOD FOR MIRROR BALLS



£ 300.00

PIXEL STORM 12 QUAD CYC BATTEN LEDJ293

12 x 15 WATT RGBW WITH 10° X 45° BEAM SPREAD, IDEAL FOR CYC LIGHTING AS VERY LITTLE DOWNSTAGE SPILL LIGHT. WIDE SIDEWAY SPREAD TO GIVE MORE EVEN COVERAGE. POWERCON IN/OUT 3 AND 5 POLE DMX IN/OUT 3/4/6/8 OR MANY CHANNELS.



£ 450.00



METEOR 150 IP65

15 X 12 WATT HEX WITH 20 X 30° RGBWAUV IDEAL FOR CYC LIGHTING WHERE THE BATTENS NEED TO BE A LITTLE FURTHER AWAY FROM THE CYC. TR1 EXTERIOR CABLE 5 POLE EXTERIOR DMX IN/OUT 3/4/6/8 OR MANY CHANNELS. UP TO 96 !



£ 700.00



LIBRETTO CYC LIGHT - 200 WATT CYC LIGHT LEDJ604

200 WATT RGBAL COB 90° H X 105°W
8 LEAF BARNDOR
5 POLE DMX IN AND OUT 5 / 9 OR 14 CHANNELS
COLOUR TEMPERATURE 2800°K 10,000°K
TRUECON IN AND OUT



£ 400.00

TZ 350 FRESNEL ELUM 109 **DIRECT IMPORT FROM CHINA**  → 

350 WATT COB RGBW WITH ZOOM FOCUS 13°- 45°
BARNDORS INCLUDED
3 AND 5 POLE DMX IN AND OUT 5 OR 7 CHANNELS
POWERCON IN AND OUT



£ 800.00

PERFORMER PROFILE 650 Q5 33064 **CHINESE IMPORT FROM E.U.**  →  → 

FROM A DIFFERENT MANUFACTURER USING THE SAME PRODUCT NAME

1 X 240 WATT 5 COLOUR LED ARRAY, RGBA- LIME
6,7,8,11,OR 17 CHANNELS OF DMX ON 3 AND 5 IN AND OUT
AS BRIGHT AS A SOURCE FOUR 575 WATT
AND ALMOST THE SAME COLOUR TEMPERATURE
GOOD YELLOWS AND ORANGES, BECAUSE OF AMBER.
CHOICE OF LENS OR USE YOUR EXISTING SOURCE FOUR LENS STOCK



LED BODY, ENGINE AND BARREL	£ 1116.00
EDLT LENS TUBE 19°, 26°, 36° AND 50°	£ 330.00
COMPLETE FITTING	£ 1446.00

BEING PHASED OUT ?

ETC COLOUR SOURCE PROFILE LUSTRE 3 **AMERICAN MADE**  →  **GUIDE PRICE**



A 7 LED SYSTEM AS BRIGHT AS A SOURCE FOUR 750. WITH HIGHER COLOUR TEMPERATURE. LIME GIVES BETTER SKIN TONES (DEGREE LEVEL PHYSICS THIS TIME) CHOICE OF LENS BARREL 5°,10°,19°,26°, 36°AND 50° HIGH DEFINITION LENS RECOMMENDED BUT YOU CAN USE ALL OF YOUR EXISTING SOURCE FOUR LENS STOCK ! 5 POLE DMX IN AND OUT. 3 / 5 / 10 CHANNELS OF DMX. HOOK CLAMP AND SAFETY BOND INCLUDED. A PROFESSIONAL PRODUCT.
50,000 HOURS EXPECTED WHICH IS ABOUT 40 YEARS AT THEATRE USAGE.

LED BODY AND ENGINE AND BARREL	£ 2644.00
EDLT LENS TUBE 19°, 26°, 36° AND 50°	£ 330.00
COMPLETE FITTING	£ 2974.00



**I'M NOT SURE MR BODGITT IS FULLY COGNISANT OF LED, DMX, RDM
OR CONVENTIONAL LIGHT AND
I'M NOT SURE HIS SON KNOWS FROM WHENCE THE LIGHT COMETH.....**

**LEDS NEED MAINTENANCE AT REGULAR INTERVALS !
SO HAVE THEM CLEANED AND PAT TESTED BY US
EACH YEAR. YOU KNOW IT MAKES SENSE !
PLEASE CALL 01322 350 351
DO YOU HAVE YOUR CAR SERVICED AND
IT'S MOT EACH YEAR ? THEN WHY NOT.....?**

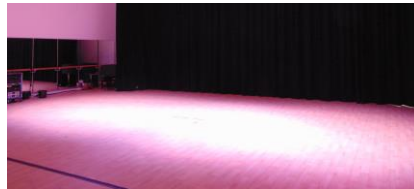

ARK GREENWICH FREE SCHOOL

LEFT, THE INSTALLER THOUGHT THAT THIS WAS ACCEPTABLE AS A WASH. WE SAID "DIM SPODGES OF LIGHT" (145 LUMENS) RIGHT, WE INSTALLED **PERFORMER HEX'S** WHICH GIVE A GOOD WASH (410 LUMENS, SAME NUMBER OF FITTINGS BUT 4 TIMES THE SIZE, 3 TIMES THE LIGHT & MORE COLOURS). ALSO A **ZERO88 FLX S24** LIGHTING DESK FOR PROPER CONTROLSO MUCH BETTER !

**A 7 X 3 WATT 15° RGB DOES NOT DO THE SAME JOB AS AN 18 X 12 WATT 40° RGBWAUV
WE OFFER THE BEST VALUE FOR MONEY EQUIPMENT.....WHICH WE USE OURSELVES.**

**CALL US IN FOR A SITE VISIT WHICH IS FREE AND WE WILL PROVIDE ALL THE INFORMATION YOU WILL NEED.
MOVING LIGHTS COME ON LONGER HOOK CLAMPS AND NYLOCK NUTS FOR SAFETY. THE HEAD DROPS BELOW
THE LEVEL OF OTHER LANTERNS GIVING MORE ROOM FOR EFFECT, WE THINK ABOUT THESE SORT OF THINGS!**

EQUINOX FUSION 100 MK 2 EQULED 069

1 X 80 WATT COB LED 10° 540° PAN X 210° TILT SMALL SIZE
NET 330 X 198 X 146 MM 4,8 KG HANGING BRACKET KIT INCL
7 COLOURS AND WHITE, 5 ROTATING GOBOS AND PRISM
IEC IN. STAND ALONE. 5/8/15 CHANNELS ON 3 POLE DMX



£ 360.00

EQUINOX FUSION 120 Q ELUM 448

120 WATT RGBW COB 540° PAN 180° TILT
TRUECON IN AND OUT
3 POLE DMX 2, 9, 12 OR 16 CHANNELS



£ 350.00

EQUINOX FUSION 200 EQULED 054

1 X 200 WATT COB 7500°K 11°-25° ZOOM
4.3 KHZ REFRESH (GOOD FOR TELEVISION)
POWERCON IN AND OUT 3 POLE DMX 2/14/18 CHANNELS
GOBO SHAKE,
7 COLOURS PLUS OPEN
7 ROTATING GOBOS, INDEXABLE, REPLACABLE, 7 FIXED GOBOS PLUS OPEN.
6 FACET ROTATING CIRCULAR PRISM AND 5 FACET ROTATING FLAT PRISM
450 X 310 X 185MM 12.7KG



£ 700.00



EQUINOX FUSION 260ZR EQUILED 024

19 X 12 WATT QUAD LED RGBW, 6°- 50° MOTORIZED ZOOM
POWERCON IN/OUT 2/8/17 OR 25 CHANNELS ON 3 POLE DMX
EYE CANDY RING
540° PAN X 270° TILT
414 X 324 X 221MM 9.7KG



£ 550.00



VORTEX COMBINED ZOOM SPOT AND WASH EQULED 073

3 X 40 WATT QUAD LED 5°- 60° RGBW
10 OR 17 CHANNELS OF DMX ON 3 POLE
540° PAN X 190° TILT MOTORISED ZOOM
400 X 290 X 330MM 7.2KG



£ 485.00

ELUMIN8 062 3200°K

2 X 100 WATT WARM WHITE LED 60° HOUSE LIGHT / BLINDER
3 / 5 POLE DMX, POWERCON IN / OUT 500 X 200 X 200MM



£ 450.00

LEDJ 376 150 WATT COB

150 WATT COB RGBA 80° WITH 50°, 40° AND 25° LENS INCL
POWERCON IN/OUT 2,4,6 CHANNELS WITH 3 AND 5 POLE DMX



£ 330.00

VERTIJET LED SMOKE MACHINE EQULED 356

DIRECT IMPORT FROM CHINA



6-8 M VERTICAL JET (CAN BE USED HORIZONTALLY AS WELL)

21 x 3 WATT LED RGB ON IEC IN
SMOKE 12,000 CU FT PER MINUTE

.7 CHANNELS OF DMX ON 3 AND 5 POLE IN / OUT

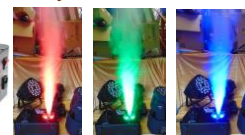

£ 340.00

VERTIBLAST LED SMOKE MACHINE NON DMX EQUILED 355

3-4 M VERTICAL JET (CAN BE USED HORIZONTALLY AS WELL)

3 X 9 WATT RGB LED. IEC IN AND REMOTE.

SMOKE APP 4800 CU FT PER MIN. 6 SECONDS PER BLAST AND 10 SECONDS TO REHEAT
(I SMOKED OUT A SCHOOL HALL INSIDE 60 SECONDS WITH 2 OF THESE, LOOKED GREAT)

£ 120.00



NEW PRODUCT

THE **DINKY** 10 WATT LED BLUE WORKING LIGHT

STOPS ACTORS WALKING INTO THE SET (SHOULD STOP...BUT THEY ARE ACTORS.)

450 X 380 X 104 MM

30 WATT VERSION



£ 30.00

£ 40.00

EXTERIOR LEDS DIRECT IMPORT FROM CHINA

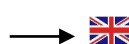

SPECTRA 40 A BIRDIE.....BUT ON STEROIDS !

40 WATT RGBW 4.5° OR 10° OR 25° IP 65 4 CHANNELS DMX



£ 250.00

LEDJ 281 EXTERIOR

15 NO 8 WATT QUAD LED RGBW 20°

IP65 RATED

4 CHANNELS, 5 POLE EXTERIOR DMX



£ 290.00

LEDJ 283 EXTERIOR

12 NO 10 WATT HEX LED RGBWAUV 25°

IP65 RATED

6/8/10 CHANNELS, 3 POLE EXTERIOR DMX



£ 320.00

ENDURA 1Q 120 ELUM 460

120 WATT COB ZOOM RGBW 13°-38° VERY BRIGHT ! TWICE THE ABOVE.

IP65 RATED 5/6/9/10 CHANNELS EXTERIOR 5 POLE DMX



£ 550.00

ASPECT FEATURE EXTERIOR LED LEDJ 386-396

3 X 3W 35° FIXED COLOUR GARDEN LIGHTS IN RED, GREEN, LIGHT BLUE, DARK BLUE, AMBER, COOL WHITE OR WARM WHITE. IP65 RATED WITH 16AMP PLUG. £ 60.00



R 386



G 388



LB 390



B 398



A 392



CW 394



WW 395

GROUND SPIKE TO GO WITH THE ABOVE LEDJ 207

£ 7.50



PHANTOM 65 SPOT 40070 **CHINESE IMPORT FROM E.U.**  →  → 

65 WATT LED 16°
540° X 270° X 16 BIT
8 OR 13 CHANNELS DMX ON 3 AND 5 POLE
POWERCON IN AND OUT
MANUAL FOCUS, HANGING BRACKET KIT INCLUDED
1 GLASS AND 6 METAL GOBOS
BI-DIRECTIONAL ROTATION, 3 FACET PRISM, GOBO SHAKE
8 DICHROIC COLOURS PLUS WHITE, SPLIT COLOURS, RAINBOW
6KG 180 WATTS



£ 750.00

PHANTOM 130 SPOT 40072

130 WATT LED 12°-21°
540° X 270° X 16 BIT
9 OR 15 CHANNELS DMX ON 3 AND 5 POLE
POWERCON IN AND OUT
MOTORIZED FOCUS, HANGING BRACKET KIT INCLUDED
7 FIXED AND 7 ROTATING GOBOS
BI-DIRECTIONAL ROTATION, 3 FACET PRISM, GOBO SHAKE
7 DICHROIC COLOURS PLUS WHITE, SPLIT COLOURS, RAINBOW
13KG 298 WATTS



£ 1300.00

SHARK SPOT ONE 45023

60 WATT LED 15°
540° X 270° X 16 BIT
8 OR 14 CHANNELS DMX ON 3 POLE IN AND OUT
IEC IN AND OUT
MOTORIZED FOCUS, HANGING BRACKET KIT INCLUDED
1 GLASS AND 6 METAL GOBOS
BI-DIRECTIONAL ROTATION, 3 FACET PRISM, GOBO SHAKE
7 DICHROIC FILTERS PLUS WHITE, RAINBOW
6.2KG, 110 WATTS



£ 533.00

SHARK WASH ONE ZOOM 45021

7 X 10 WATT QUAD RGBW 6°- 36°
540° X 270° X 16 BIT
8 OR 15 CHANNELS DMX ON 3 POLE IN AND OUT
IEC IN AND OUT, HANGING BRACKET AND KIT INCLUDED
4.7KG, 80 WATTS



£ 481.00

A WHOLE NEW VERSION OF THE BIRDIE ! THE SIZE IS 16 X 1/8TH INCH OR 20 OR 30 TIMES 1/8TH
DIMS ON CONVENTIONAL DIMMERS WITH TRUE TUNGSTEN HALOGEN DIMMER CURVE.

CHINESE IMPORT FROM E.U.  →  → 

PAR 16 LED 43311

10 WATT LED 36° .3KG
1800° K - 2700° K - ON DIM
FEED FROM CONVENTIONAL DIMMER NO UV *SAFE IN HISTORIC BUILDINGS*
PLUG, BASE OR HOOK CLAMP ETC EXTRA



£ 49.00

PAR 20 LED 43312

15 WATT LED 45° .6KG
TECH SPEC AS ABOVE



£ 70.00

PAR 30 LED 43313

20 WATT LED 45° .9KG
TECH SPEC AS ABOVE



£ 84.00



SHOWTEC ACT CYC 34042

200 WATT RGBAL CYC FLOOD
90° H X 105°V
2800° - 10,000° K
POWERCON IN 3 POLE DMX 5,8 OR 12 CHANNELS



£ 580.00

SHOWTEC ACT 50 FRESNEL 34013

150 WATT RGBAL FRESNEL
23°-53°
2800° -10,000° K
POWERCON IN AND OUT
3 POLE DMX IN AND OUT 5,8,12 CHANNELS OF DMX



£ 468.00

SHOWTEC ACT 150 FRESNEL 34014

280 WATT RGBAL FRESNEL
30°-50°
2800°- 10,000°K
POWERCON IN AND OUT
3 POLE DMX IN AND OUT 5,8,12 CHANNELS



£ 700.00

AFX

AFX CLUB ZOOM 2810 IP65

28 X 10 WATT RGBW
ELECTRONIC ZOOM 12° -60°
13/29 CHANNELS OF 3 POLE EXTERIOR DMX IP65
POWERCON IN AND OUT PROVISIONAL PRICE



£ 500.00

AFX BEEDREAM 1940

19 X 40 WATT RGBW WITH 42 NO .2W RGB LED RING
ELECTRONIC ZOOM 6°- 60° WITH HARD BEAM OF 4°
26/38.102/114 CHANNELS OF 3 POLE DMX
ROTATING LENS AND PETAL EFFECT (MULTI BEAM)
COLOUR TEMPERATURE 2800°- 8000°K
POWERCON IN AND OUT PROVISIONAL PRICE



£ 2300.00

AFX WASH 1940

19 X 40 WATT RGBW WITH 42 NO .2W RGB LED RING
ELECTRONIC ZOOM 6°- 60°
24/30/112 CHANNELS OF 3 POLE DMX
COLOUR TEMPERATURE 2800° - 8000°K
POWERCON IN AND OUT PROVISIONAL PRICE



£ 2000.00

AFX WASH 760 FC

7 X 60 WATT RGBW WITH 39 NO .2W RGB LED RING
ELECTRONIC ZOOM 6°- 60°
24/36/64 CHANNELS OF 3 POLE DMX
COLOUR TEMPERATURE 2700° - 8000°K
POWERCON IN AND OUT PROVISIONAL PRICE



£ 1500.00



FOLLOW SPOTS

ROBERT JULIAT SULLY FOLLOW SPOT E.U. MADE →

115 WATT LED FOLLOW SPOT 10.5°- 22.5° 5700°K SO MATCHES CARBON ARC.
6 COLOUR MAG BUILT IN. COMES WITH STAND AND BALL RACE SPIGOT. BRIGHTER
THAN 1200 WATT TUNGSTEN (CANTATA) **PERFECT DIMMING (NO DROP OFF)**

£ 3645.00



ROBERT JULIAT ROXIE 2 LED

300 WATT LED FOLLOW SPOT 10°-20° WITH 5000°K LED ENGINE. MATCHES CARBON ARC.
COLOUR MAG WITH BUILT IN COLOURS. CHANGEABLE WITH LEE COLOUR RANGE.
LONG LIFE EXPECTED TBC. DIMMER KNOB BY THE SIDE HANDLE, GOBO SLOT AND
BLACKOUT IRIS, **PERFECT DIMMING (NO DROP OFF)** COOL RUNNING. INCLUDES STAND
AND BALL RACE SPIGOT. WOULD BEAT A 1KW CSI, PATT 765 OR THE LIKE.

£ 4730.00



ROBERT JULIAT OZ AND ALICE E.U. MADE →

600 WATT LED FOLLOW SPOT. OZ 7°-14° LONG THROW OR ALICE 14°-24° SHORT THROW
6000°K LED ENGINE. (MATCHES 1200 WATT HMI OR BRIGHTER) COLOUR MAG WITH
CHANGEABLE FILTERS. USE LEE FILTER. LONG LIFE EXPECTED TBC.
DIMMER KNOB ON THE SIDE HANDLE, GOBO SLOT AND BLACKOUT IRIS,
PERFECT DIMMING (NO DROP OFF) COOL RUNNING. INCLUDES, STAND AND BALL RACE
SPIGOT. PROFESSIONAL EQUIPMENT.

OZ LONG THROW £ 9818.00

ALICE SHORT THROW £ 9998.00



OZ



ALICE

THE DFS "DMX LIFE SAVER KIT" FOR THE PLONKER WHO FORGETS EVERYTHING !

1 OFF EACH:- 3-5 POLE AND 5-3 POLE ADAPTERS, 3 POLE AND 5 POLE TERMINATOR,
13A-IEC, 13A-POWERCON CABLE , 3 POLE DMX PHASE REVERSE CABLE £ 50.00

NEW PRODUCTS COMING TO MARKET MONTHLY...ALMOST WEEKLY !

PLEASE ENQUIRE..... CONTACTUS@DAVIDFITCHSERVICES.COM



'OW much?



CONVENTIONAL LANTERN JUST ONE COLOUR !	1974	WITH INFLATION TODAY ...APPROX. WHAT IT MIGHT COST	LED EQUIVALENT
PATT 23	£ 38	£ 463	VIRTUOSO 600 £ 800 BUT 4 TIMES AS BRIGHT AND MORE !
SOURCE 4 JR 2 DISCONTINUED OCT 2024	TODAY	£ 596	GREAT BUT JUST ONE COLOUR !
PATT 264	£ 72	£ 878	VIRTUOSO 600 £ 800 JUST ONE COLOUR
SOURCE 4 50°	TODAY	£ 721	VIRTUOSO 1000 £ 1000 GREAT BUT JUST ONE COLOUR !
PATT 123	£ 44	£ 536	VIRTUOSO 1000 £ 1000
PATT 743	£ 62	£ 756	MP 75 FRESNEL £ 280
SOURCE 4 FRESNEL	TODAY	£ 691	MP 180 FRESNEL £ 700 GREAT BUT JUST ONE COLOUR !
PATT 137	£ 20	£ 244	MP 180 FRESNEL £ 700
PATT 60	£ 33	£ 402	PERFORMER 200 £ 200
S 63 BATTEN 3 COLOUR WASH	£ 70	£ 854	PERFORMER HEX £ 250
CODA 4 1993 4 COLOUR WASH	£ 352	£ 735	PIXEL STORM 12 QUAD £ 450
PATT 765 FOLLOW SPOT	£ 500	£ 6100	PIXEL STORM 12 QUAD £ 450 ROXIE 300 £ 4730

PLEASE ASK FOR OUR STATE OF THE ART CARD FOR PICTURES.



**OK, SO IT'S CHEAPER NOW
THAN "WHEN I WERE A LAD"**

CHILD PROTECTION ISSUES ? NO, IT'S ME, MAKING MY DEBUT IN 1957.



NOTES

- **SWITCHING THE DESK OFF AT NIGHT BUT LEAVING THE RACKS ON, COSTS YOU MONEY ! ON A 60 AMP CONVENTIONAL SYSTEM THIS COULD BE £ 5000 PER YEAR WASTED.**
THE SIMPLE SOLUTION, TURN THE RACKS OFF AT THE END OF THE DAY.
SOME RACKS CAN RUN AT ABOUT 25% ON STANDBY.
IT WOULD BE LIKE PUTTING THE CAR IN THE GARAGE AND LOCKING IT BUT KEEPING THE ENGINE RUNNING, YOU WOULDN'T DO IT AT HOME. JUST SWITCH IT OFF. A RETROFIT CONTACTOR SYSTEM IS AVAILABLE WHICH WILL ALLOW YOU TO DO THIS FROM A KEY SWITCH.
- **SWITCH THE PROJECTOR AND LIGHTS OFF. WE SAW A SCHOOL RECENTLY LEAVE A PROJECTOR ON AFTER ASSEMBLY FOR THE WHOLE DAY WITH NO ONE IN THE HALL. THE PROJECTOR LAMP COSTS OVER £ 300 AND ONLY HAS A LIMITED LIFE. ALSO IN THAT HALL THERE WERE 54 NO 65 WATT FLOURESCENT TUBES ON ALL DAY COSTING £ 1 PER HOUR TO ILLUMINATE NOTHING. MULTIPLY THAT BY 6 HOURS A DAY FOR 200 DAYS A YEAR, SAVING ANOTHER £ 1200 ...EVERY LITTLE HELPS. NOW WHERE HAVE I HEARD THAT LINE ? WE SWITCHED THEM OFF WHEN WE LEFT....SO EASY !**
- **WITH SMOKE AND HAZE MACHINES, RUN DISTILLED WATER THROUGH THEM EVERY 6 MONTHS OR SO. SIMPLY PUT THE MACHINE ON AND DIP THE FEED HOSE INTO DISTILLED WATER. WHEN THE SMOKE BECOMES WATER VAPOUR, NOT STEAM, I LEARNED THAT FROM QI, FOR A FEW SECONDS, STOP AND PUT THE SMOKE FLUID BACK AND RUN UNTIL THE WATER VAPOUR BECOMES SMOKE AGAIN. SMOKE MACHINES LIVE LONGER WITH....A SIMPLE CLEAN. (DON'T USE THE WELL KNOWN CLEANING PRODUCT)**
- **SWITCHING ON A DMX LIGHTING SYSTEM, RACKS FIRST THEN DEMUX, LEDS AND MOVING LIGHTS THEN THE DESK. TO SWITCH OFF, REVERSE THE ORDER.**
- **YOUR DIMMER SYSTEM SHOULD HAVE RCD PROTECTION. TEST THE RCD BY PRESSING THE TEST BUTTON EVERY 3 MONTHS OR SO, WE SUGGEST THE START OF EACH HALF TERM. IT TAKES ABOUT 30 SECONDS, JUST LIKE A DOMESTIC SMOKE ALARM. IF YOUR SYSTEM DOES NOT HAVE RCD'S, PLEASE ASK US TO VISIT TO ADVISE THE BEST WAY FORWARD.**
- **YOUR LIGHTING SYSTEM SHOULD BE REGULARLY SERVICED INCLUDING PAT TESTING AND I DON'T MEAN 23 YEARS AFTER WE INSTALLED THE SYSTEM AS ONE OF OUR REGULAR CUSTOMERS DID. WE HAVE SEEN IN A SCHOOL WHERE THE RIG WAS 'TESTED' BY OTHERS BUT WE KNOW THAT IT WAS JUST A STICKERING EXERCISE AS THE DUST HAD NOT BEEN DISTURBED. I ALSO KNOW BECAUSE I WAS THE LAST PERSON TO USE THOSE LIGHTS AND I KNOW HOW I LEFT THE RIG. WE ALSO KNOW THAT THE CUSTOMER WAS RIPPED OFF AS THEY WERE CHARGED FOR PAT TESTING WHICH WAS NOT DONE ! SHOULD HAVE GONE TODAVID FITCH SERVICES !**
- **UNCOIL CABLES FULLY AS YOU HAVE "AN ELECTRIC MOTOR GOING NOWHERE". IT OVERHEATS AND BURNS OUT.**
- **THE MICROPHONES **MUST** BE BEHIND THE SPEAKER LINE OR FEEDBACK IS INEVITABLE !**
- **DUMPING CABLES AND OTHER HEAVY ITEMS ON THE SOUND DESK OR LIGHTING DESK..... IS BOUND TO CAUSE DAMAGE. CAN I PUT A STAGE WEIGHT ON YOUR I-PHONE ? THOUGHT NOT.**
- **NO DRINKS OR FOOD NEAR THE TECH GEAR.... GREASE, ESPECIALLY CRISPS ! , MESS AND STICKY MARKS ON YOUR TOUCHSCREEN..... IF NOT TOTAL DESTRUCTION OF THE KIT !**
- **PLEASE USE WHITE PVC TAPE AND A CD MARKER PEN TO MARK UP THE DESKS, WHICH WE SELL, NOT MASKING TAPE AS IT LEAVES A STICKY MESS AND BIRO IS A COMPLETE PAIN IN THE...DARK !**
- **NO MOBILE PHONES OR SOCIAL MEDIA WHEN RUNNING THE SHOW ! AS MISSED CUES ARE ALL TOO OBVIOUS. WE SHOULD BE PROFESSIONAL,.....EVEN IF UNPAID.**
- **WHEN BUYING EQUIPMENT PLEASE REMEMBER,**

BUY CHEAP, BUY TWICE !

CHEAP IS OFTEN FOLLOWED BY NASTY !

DO IT ONCE, DO IT RIGHT !

AND..... NOT ALL LEDS ARE CREATED EQUAL !



NOTES-TERMS AND CONDITIONS 1ST FEBRUARY 2021

ALL ORDERS MUST BE CONFIRMED IN WRITING, WITHOUT THIS NO ORDER EXISTS AND REQUESTS WILL NOT BE ACTED UPON. WHEN ORDERING PLEASE LET US KNOW THE DATE YOU REQUIRE THE GOODS, THE DATES OF THE PERFORMANCES, THE EXPECTED FINISHING TIME OF THE LAST PERFORMANCE AND THE TIME AT WHICH THE GOODS WILL BE RETURNED OR COLLECTED. PLEASE LET US KNOW OF ANY IMPORTANT INFORMATION SUCH AS THE VENUE WILL SHUT. "LOCKED IN" EQUIPMENT REMAINS ON HIRE TO YOU! IF THERE IS SOMETHING YOU DO NOT UNDERSTAND PLEASE ASK. WE WILL SEND AN INSTRUCTION SHEET WITH MORE TECHNICAL ITEMS. HIRE CHARGES ARE PER WEEK (OR 50% OF THE WEEKLY RATE FOR 24 HOURS, DAY RATE). DISCOUNT IS AVAILABLE ON 4 WEEKS OR MORE HIRE. IN OUR BROCHURES, ITEMS MARKED * DO NOT COME INTO THE DAY RATE SCHEME.

INVOICES ARE ALL DUE NET 10 DAYS FROM THE DATE OF INVOICE (NORMALLY THE DATE ON WHICH THE GOODS ARE DESPATCHED). NEW ACCOUNT CUSTOMERS ARE INVITED TO PAY BY BACS BEFORE DISPATCH. PRICES QUOTED IN OUR BROCHURES ARE CORRECT AT TIME OF GOING TO PRESS. PLEASE CONFIRM THE PRICE WHEN ORDERING. TRANSPORT IS NOT DISCOUNTED. WE RESERVE THE RIGHT TO SUBMIT PART INVOICES IF THE ORDER IS MORE THAN **£100.00 NET (SALES)** THIS IS DUE TO TRADING CONDITIONS ON ALL CHINESE GOODS. PRICES MAYBE SUBJECT TO VAT. SHOULD YOU NEED TO HAVE THE INVOICE DETAILS CHANGED IT SHALL HAVE NO EFFECT ON THE INVOICE DATE OR DATE BY WHICH THE INVOICE MUST BE PAID AND THE ORIGINATOR OF THE ORDER WILL STILL BE RESPONSIBLE FOR THE DEBT UNTIL PAID. WE MAY LEVY A CHARGE FOR THIS. ALL PAYMENTS MUST BE SENT WITH A REMITTANCE ADVICE NOTE, BACS PAYMENTS MUST BE ADVISED IN THE SAME WAY. WE RESERVE THE RIGHT TO CHARGE 10% PER MONTH FOR LATE PAYMENT OF INVOICES, CALCULATED ON A DAILY BASIS FROM THE DUE DATE UNTIL PAID. SHOULD YOU WISH TO CHANGE THE DATES FOR A HIRE YOU MUST NOTIFY US AS SOON AS POSSIBLE AS WE MAY NOT BE ABLE TO ASSIST DUE TO OTHER BOOKINGS. LIKEWISE, IF YOU DECIDE TO RETURN EARLY, OR CANCEL AT SHORT NOTICE, WE MAY NOT CREDIT YOU. ONCE YOU HAVE ORDERED AND RECEIVED GOODS THEY WILL BE CHARGED TO YOU, WHETHER THEY ARE USED OR NOT. IF YOU WISH TO CANCEL A BOOKING YOU MUST DO SO IN WRITING AT LEAST 7 DAYS BEFORE THE HIRE. WE WILL NOT CREDIT SUCH EQUIPMENT AT LESS THAN 7 DAYS WRITTEN NOTICE.

IF AN ITEM OF OUR EQUIPMENT GOES WRONG PLEASE CHECK FOR THE OBVIOUS SUCH AS A BLOWN FUSE, A FLAT BATTERY ETC. IF IT IS MORE SERIOUS WE WILL RECTIFY THE FAULT AS QUICKLY AS POSSIBLE. PLEASE RETURN THE ITEM TO US FOR INSPECTION. IF WE HAVE DELIVERED IT, WE WILL COLLECT AND RETURN. PLEASE REPORT ANY FAULTS **AT ONCE, AS NO ALLOWANCE CAN BE MADE** IF THE FAULT IS REPORTED TO US AT THE RETURN OF THE EQUIPMENT. IF THERE IS AN ITEM MISSING PLEASE CALL AND TELL US SO THAT WE CAN DISPATCH SAID ITEM AS SOON AS POSSIBLE. BATTERIES AND FILTER ARE THE CUSTOMER'S RESPONSIBILITY. **DAVID'S MOBILE 07860 233 771**

SMOKE MACHINES GET VERY HOT AND MAY WELL SET OFF THE FIRE ALARM; ALSO PYROTECHNICS WILL SET OFF THE FIRE ALARM. THEREFORE, PLEASE ISOLATE THE ZONE. WE WILL NOT ACCEPT ANY RESPONSIBILITY FOR SUCH AN EVENT. PYROTECHNICS CAN BE VERY DANGEROUS IF ABUSED. PLEASE TREAT THEM EXACTLY LIKE FIREWORKS - WITH GREAT CARE - AND FOLLOW THE INSTRUCTIONS PROVIDED. WHEREVER POSSIBLE KEEP LIGHTING AND SOUND CABLES APART, THIS WILL HELP TO AVOID INTERFERENCE. OUR DIMMER RACKS ARE SUPPLIED WITH 1.5 METRES OF CABLE AND A 63 AMP PLUG. LANTERNS ARE FITTED WITH 1.5 METRES OF SILICON FLEX AND A 15 AMP PLUG OR 16 AMP ON OUTDOOR FITTINGS AND NON-DIM ITEMS. ADAPTORS CAN BE SUPPLIED AT EXTRA COST. PLEASE DO NOT CHANGE ANY PLUG OR SOCKET, AS WE WILL MAKE A CHARGE FOR REPAIRS AND RE-TESTING. NON-DIMMING ITEMS WILL BE SUPPLIED WITH A SUITABLE 13 – 16 AMP ADAPTOR FREE OF CHARGE. WE WILL INFORM YOU OF THE DETAILS. DO NOT PUT A NON-DIM ITEM ON A DIMMER. DO NOT ALTER ANY OF OUR EQUIPMENT, AS YOU WILL BE CHARGED FOR ITS REPAIR OR REPLACEMENT.

PLEASE DO NOT USE PARCEL TAPE OR MASKING TAPE, AS IT IS NOT SUITABLE FOR TAPING DOWN CABLES. THESE TAPES ARE VIRTUALLY IMPOSSIBLE TO CLEAN OFF. WE SELL GAFFA TAPE WHICH IS REALLY VERY CHEAP, AND FAR MORE SUITABLE. THE CUSTOMER IS RESPONSIBLE FOR CLEANING OFF GAFFA TAPE OR OTHER TAPES USED ON YOUR PRODUCTION. WHEN RE-COILING CABLES PLEASE USE THE CORRECT METHOD AND USE RESEALABLE CABLE TIES, WHICH WE CAN SUPPLY, OR PVC TAPE BUT NOT MASKING TAPE, GAFFA TAPE OR SELLOTAPE. POORLY COILED CABLES, OR CABLES NOT COILED AND SECURED, WILL BE CHARGED, AS THIS TAKES TIME TO CORRECT. THERE IS A BOOKLET AVAILABLE TO DOWNLOAD BY US WITH EACH HIRE TO HELP YOU. BARNDOORS SHOULD ALSO BE CLOSED AND LEFT ON THE LANTERN. ON PROFILES, SHUTTERS SHOULD BE IN. LOST EQUIPMENT SUCH AS HOOK CLAMPS, COLOUR FRAMES, SAFETY CHAINS/BONDS OR BARN DOORS WILL BE CHARGED IN FULL.

SHOULD A LAMP "BLOW" PLEASE RETURN THE LAMP FOR INSPECTION. NON-RETURNS WILL BE INVOICED. THE CUSTOMER IS RESPONSIBLE FOR INSURANCE OF THE EQUIPMENT WHILST IN THEIR POSSESSION. PLEASE ENSURE YOU HAVE ADEQUATE COVER! IF DAMAGE OCCURS, THE CUSTOMER WILL BE CHARGED FOR REPAIRS AT COST (REPLACEMENT IF NECESSARY) AND MAY BE CHARGED FOR CONSEQUENTIAL LOSS DURING REPAIRS. ALL HIRE EQUIPMENT REMAINS THE PROPERTY OF DAVID FITCH SERVICES AND WE RESERVE THE RIGHT TO INSPECT THE EQUIPMENT AT THE CUSTOMERS PREMISES AT A REASONABLE TIME AND NOTICE. WE WILL TRY TO SUPPLY EQUIPMENT AS ORDERED BUT RESERVE THE RIGHT TO SUBSTITUTE SIMILAR EQUIPMENT SHOULD THE SAID GOODS BE UNAVAILABLE. IF WE HAVE TO SUBSTITUTE SUPERIOR OR MORE EXPENSIVE EQUIPMENT YOU WILL BE CHARGED AT THE LOWER RATE. WE CANNOT BE HELD LIABLE FOR CONSEQUENTIAL LOSS IN RELATION TO LATE RETURN OF GOODS OR IN REHEARSAL PERIOD WHILST WE ARE RECTIFYING ANY PROBLEM. LATE RETURN OF GOODS WILL BE CHARGED FOR IN FULL AT THE PUBLISHED RATES.

DELIVERY AND COLLECTION IS AVAILABLE ON ALL EQUIPMENT, BUT IS A CHARGEABLE SERVICE. THIS WILL BE BETWEEN 8AM AND 6PM OR BY ARRANGEMENT. NB WE CANNOT GUARANTEE TIMES DUE TO TRAFFIC CONDITIONS. UNSOCIAL HOURS, 11PM-6AM ATTRACTS A SURCHARGE. OCCASIONALLY, WE MAY HAVE TO DELIVER AT AN EARLIER TIME OR COLLECT GOODS AT THE NEXT OPPORTUNITY DUE TO COMMITMENTS, YOU WILL NOT BE CHARGED EXTRA FOR THIS. CERTAIN GOODS CANNOT BE SENT BY POST OR CARRIER, GOODS SUCH AS: PYROTECHNICS, FLUIDS, PAINT OR LARGE FRAGILE ITEMS. WE WILL ADVISE YOU AT THE TIME OF ORDERING OF SUCH ITEMS. PLEASE BE DE-RIGGED IN TIME, AS WASTED JOURNEYS WILL BE CHARGED AT CURRENT RATES. WE TRY TO FLIGHTCASE EQUIPMENT WHEREVER POSSIBLE TO PROTECT IT AND MAKE TRANSPORT EASIER, PLEASE USE THE CASES WHICH ARE LEFT ON SITE FOR RETURNING THE EQUIPMENT. THERE IS A BOOKLET SUPPLIED WITH EACH HIRE TO ASSIST YOU IN PACKING THE CASES. PLEASE ASK FOR THE FLIGHTCASE SIZES AND IF COLLECTING PLEASE BRING AN APPROPRIATE VEHICLE. WITH STAGEBASE OR STEELDECK, WHEN WE DELIVER OR COLLECT, THE DRIVER WILL GET THE VEHICLE AS CLOSE AS PRACTICAL. YOU WILL BE EXPECTED TO SUPPLY FIT PEOPLE TO MOVE THE DECK, TO AND FROM ITS PLACE OF USE. IF YOU WOULD LIKE US TO FIT OR REMOVE THE DECK WE WILL SEND A SECOND PERSON. THIS MUST BE ARRANGED AT TIME OF ORDER AND IS CHARGED FOR ACCORDINGLY. STAIRS WILL INVOLVE EXTRA COSTS AND YOU MUST ADVISE US OF THE ACCESS ROUTE AND SITE CONDITIONS. WHEN HIRING MIRROR BALLS OUR RIGGING EQUIPMENT MUST BE USED TO SUPPORT THEM, NO OTHER METHOD IS ACCEPTABLE. DO NOT ALTER ANY ITEM OF OUR EQUIPMENT AND DO NOT REMOVE MARKING TAGS. PLEASE NOTE THE SIZE OF THE FLIGHTCASES AND MEASURE THE ACCESS. NO ALLOWANCE WILL BE MADE IF THIS IS NOT DONE. ALL SIZE INFORMATION IS ON OUR WEBSITE.

REPAIRS TO CUSTOMER EQUIPMENT IS UNDERTAKEN ON, THE TIME TAKEN PLUS COMPONENTS REPLACING SUCH AS REQUIRED TO EFFECT REPAIRS OR ESTABLISH ECONOMIC REPAIR OR NOT.

THESE TERMS AND CONDITIONS WILL APPLY WHETHER YOU HAVE READ THEM OR NOT. TITLE OF SALES ITEMS REMAINS WITH DAVID FITCH SERVICES UNTIL THE INVOICE IS PAID CLEARED FUNDS. GOODS CORRECTLY SUPPLIED BUT SUBSEQUENTLY RETURNED ARE SUBJECT TO A RE-STOCKING CHARGE. SPECIALIST ITEMS CANNOT BE RETURNED.

CONTACT DETAILS TEL 01322 350 351 MOBILE 07860 233 771 E-MAIL contactus@davidfitchservices.com



DATES FOR THE SHOW

CUSTOMER _____

2024

SHOW _____

ORDER DATE _____

DELIVERY DATE _____

FIT UP _____

TECHNICAL 1 _____

TECHNICAL 2 _____

DRESS REHEARSAL _____

1ST PERFORMANCE _____

LAST PERFORMANCE _____

GET OUT _____

COLLECTION _____

NERVOUS BREAKDOWN (OPTIONAL) _____



WHEN SOMEONE SAYS, "I'LL LEND YOU THE GEAR", DON'T BELIEVE THEM! WE HEAR THIS EVERY WEEK. PLACE YOUR WRITTEN ORDER WITH US AND WE HAVE AGREED.....IT WILL HAPPEN!BUT TRY TO GIVE US A BIT OF NOTICE ...PLEASE!



TELEPHONE 01322 350 351
MOBILE (EMERGENCY OR OUT OF HOURS) 07860 233 771
EMAIL CONTACTUS@DAVIDFITCHSERVICES.COM
WEBSITE WWW.DAVIDFITCHSERVICES.COM

REMEMBER, YOU MUST SEND A WRITTEN ORDER!
OPEN MONDAY-FRIDAY 9AM-6PM SATURDAY 11AM-1PM TERM TIME
CLOSED SUNDAYS AND BANK HOLIDAYS!
BUT PLEASE CHECK WE ARE IN BEFORE DROPPING IN!

ALL I SAID WAS "IT WILL LOOK ALRIGHT, WHEN IT'S LIT"

PLEASE SEE OUR WEBSITE FOR MORE INFORMATION AND VIDEO CLIPS ON FACEBOOK WWW.DAVIDFITCHSERVICES.COM